

SANI-CEPTOR® FUNNEL-CEPTOR® ROOF-CEPTOR® TECHNICAL DATA SECTION



PLUMBING CODE REQUIREMENTS

Indirect waste pipe is defined as a pipe that does not connect directly to the waste system but conveys liquid waste by discharging into a plumbing fixture (indirect waste receptor, floor sink, or similar code approved fixture) which is directly connected to the waste system. This installation provides an air gap which prevents contamination of food handling and other equipment required by code to be indirectly connected. Most code authorities require the receptor to have smooth, easy to clean corrosion-resistant interior surfaces. **Regular floor or hopper drains do not conform to these requirements because they have rough interiors with pockets and crevices which can harbor dirt and bacteria. These unsanitary conditions can spread disease, create unpleasant odors, and endanger human lives.**

SMITH DEVELOPMENT

In the early 1960's, Smith developed a complete line of **Sanitary Indirect Waste Receptor Drains** for installation in non-traffic areas. The interiors of the receptors had large radius corners, were ground smooth, and had an acid resistant coating applied making them easy to clean. A full line of dome strainers, sediment buckets, partial grates, covers, and funnels was developed. **There was a Smith Sanitary Indirect Waste Receptor Drain for every need. All conformed to the requirements of the most demanding plumbing codes.**

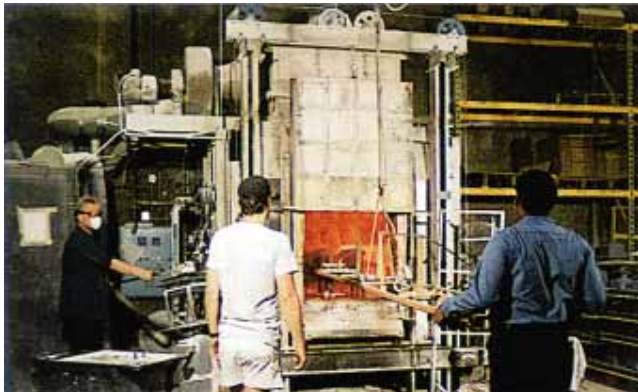

Fig. 1

A view of the acid resistant coating facility located in the modern Smith factory

A demand developed for these Sanitary Indirect Waste Receptor Drains to be installed in traffic areas. Smith responded with a complementary line of **Sanitary Floor and Area Drains**. Hundreds of thousands of these sanitary drains have been installed throughout the nation and in many foreign countries. This success led to the trademarked brand names **Sani-Cepto[®]**, **Funnel-Cepto[®]** and **Roof-Cepto[®]** to identify the expanded product lines.

Through the years, Smith has found a growing need for an even more rugged, durable and corrosion-resistant **SANI-CEPTOR**. Again leading the way, **Smith engineers have developed a STAINLESS STEEL SANI-CEPTOR**. Today there is a body type and size available for every requirement and a top design for every need. **This wide selection, coupled with the Smith catalog numbering system, permits the specifier to "custom design" the SANI-CEPTOR to suit the individual needs of the particular application at mass production costs.**

SANI-CEPTOR USAGE

SANI-CEPTORS used as **sanitary indirect waste receptors** are required by modern plumbing codes in buildings where food is handled or

processed such as restaurants, cafeterias, food markets and food processing plants. **SANI-CEPTORS** used as **sanitary floor and area drains** are essential in locations where human life could be endangered due to lack of sanitation such as hospitals, nursing and convalescent homes, clinic rooms and laboratories; also food processing plants such as dairies, creameries and breweries. These vital areas must be kept absolutely clean because the function which they serve is connected with the health and well-being of people. **When sanitation, durability and longevity are considered, SANI-CEPTORS are the most cost effective drains for most applications.**

HOW TO SELECT A "SANI-CEPTOR"®

Analyze the requirements in the following categories:

- Selection of Materials
- Selection of Receptor/Body
- Selection of Internal Strainers and Buckets
- Selection of Tops
- Selection of Special Application Items

• Selection of Materials

Smith SANI-CEPTORS are constructed in two basic types:

- 1) **14 Gage type 304 stainless steel -SS body, SS internal strainers and buckets, and SS or Nickel Bronze tops.**
- 2) **Heavy cast iron body with acid resistant coated (A.R.C.) interior, aluminum internal strainers and buckets and nickel bronze or A.R.C. tops.**

Stainless steel SANI-CEPTORS are seamless deep drawn and fabricated from 14 gage type 304 stainless steel sheet. This heavy metal assures a rugged product. Type 304 SS is one of the most corrosion-resistant of the widely used stainless steels. For even greater corrosion resistance to certain chemicals, type 316 SS is offered as an optional material. In selecting the proper stainless steel for your particular application, please refer to catalog page 9-16.

Strainers and Buckets for A.R.C. SANI-CEPTORS are furnished in light weight corrosion resistant aluminum because dropping a heavy cast iron strainer or bucket could chip or damage the coating causing almost irreparable damage. **Stainless Steel** SANI-CEPTORS are furnished with SS strainers and buckets. Since there is no coating to chip or damage, this potential problem is eliminated.

SS Tops or NB Rims and Grates are available for traffic areas and indirect waste applications. Both have excellent corrosion resistant qualities and are extremely serviceable where food waste and food acids are encountered. Neither will discolor like brass or bronze and both offer a "lasting" silver appearance. The polishing of a terrazzo floor and the "scuff-buff" action of foot traffic passing over a SS or NB top will actually add to its appearance. A.R.C. SANI-CEPTORS are available with cast iron grates and tops for non-traffic areas.

• Selection of Receptor Body

The body size and depth are determined by the anticipated use. Where large flow rates are anticipated, bodies with greater capacity should be used. Where SANI-CEPTOR drains are used for an indirect waste application, it is important to select a body with sufficient depth to prevent splashing. The need for a large capacity sediment bucket will necessitate the selection of a deep body. Round bodies are more easily cleaned than square bodies; however, all Smith square or rectangular bodies are designed with large radius corners to facilitate cleaning.

Following are body types, options and recommendations:

1) **BODY WITH ANCHORING OR SEEPAGE CONTROL FLANGE** (Fig. 2). This flange rigidly anchors the body in the concrete slab. Body is provided with holes to control the seepage which occurs due to normal separation between the concrete and the SANI-CEPTOR body. Waterproofing membranes are used in many floors on grade. They should always be used in floors located above grade. When a membrane is used, Smith flange and optional flashing clamp (Fig. 3) must be specified. To indicate, add suffix -F-C to the selected figure number.

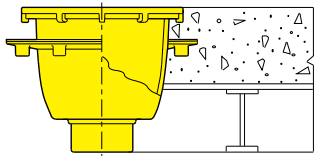

Fig. 2

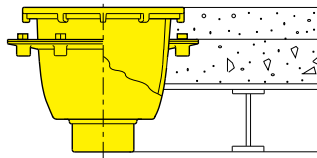

Fig. 3

2) **BODY WITH WIDE TOP FLANGE:** Prefix DX stainless steel SANI-CEPTORS are designed for installation in wood decking over 16" C/C joists (Fig. 4). Top flange is 3/16" below drain rim and grate to accept standard thickness waterproof covering (A). Covering manufacturers require top of wide flange be installed approximately 1/8" below decking. This is accomplished automatically when using 3/4" plywood (C) which permits waterproof covering to be sloped (dimpled) toward drain grate (D). Drain flange is regularly provided with countersunk anchor holes for optional screws or bolts which can secure flange to deck. Wood screws furnished when specified (B).

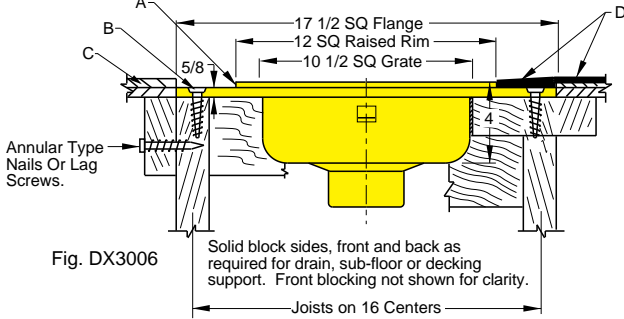

Fig. DX3006

Fig. 4 Typical installation in wood floor or deck.

(LH view shows use of 3/4" exterior plywood as decking. RH view shows same installed over sheathing or T & G sub-floor).

These SANI-CEPTORS are also perfectly suited for installation in concrete floors and decks (Fig. 5). Anchor clips securely anchor the drain body into concrete (G). Optional anchor bolts, washers and nuts furnished when specified (F). Optional screed guides set top flange approximately 1/8" below the concrete surface as required (E). See (A) above for details.

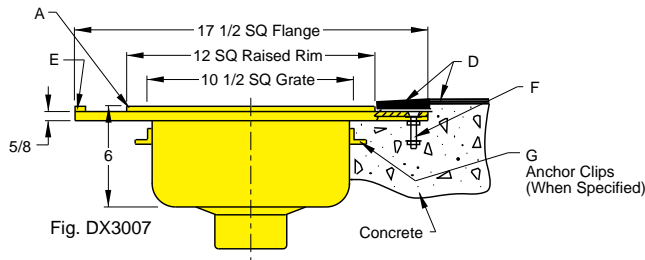

Fig. DX3007

Fig. 5 Typical installation in concrete floor or deck.

NOTE: Use of drain body with 6" minimum depth prevents concrete from surrounding waste connection when installed on grade and makes forming easier above grade.

Prefix DX cast iron SANI-CEPTORS are shown in this catalog section. They are installed similar to other Prefix DX drains shown in Roof and Floor Drain Sections.

3) **TRAP PRIMER CONNECTION:** To indicate a trap primer connection on a Smith stainless steel SANI-CEPTOR body, add Suffix -P to the figure number selected. Connection is located on vertical C/L 2" above bottom of drain (Fig. 6). These connections are not recommended for A.R.C. SANI-CEPTORS because the exposed pipe threads rust causing an objectionable discoloration on the A.R.C. wall. When a trap primer connection is needed for A.R.C. applications, Smith recommends the use of Auxiliary Inlet Fitting Fig. 2697 (Fig. 7).

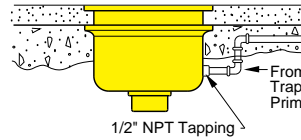

Fig. 6

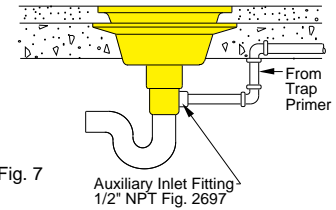

Fig. 7

• Selection of Internal Strainers and Buckets

Dome bottom strainers or buckets are regularly furnished as indicated by the figure number of the SANI-CEPTOR selected.

Dome and Flat Bottom Strainers: Dome Type (Fig. 8A) are preferred because their hemispherical design greatly reduces splashing and the large free area prevents clogging, and assures maximum flow. Flat Type (Fig. 8B) are recommended only when a bottom strainer is required for installation in A.R.C. models beneath aluminum buckets where there is insufficient clearance to utilize the dome type. This optional bottom strainer protects the waste line when bucket is removed.

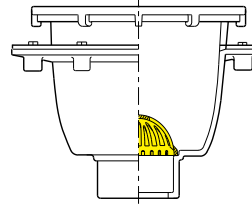

Fig. 8A
Dome Bottom Strainer

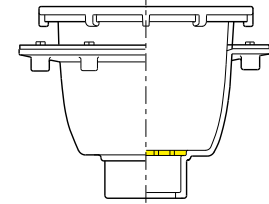

Fig. 8B
Flat Bottom Strainer

Perforated or Slotted Sediment Buckets: Both are suitable for normal installations to intercept and retain foreign materials and solids such as bones, pits, scrap, peelings and other commonly encountered debris. Perforated buckets (Fig. 8C) are regularly furnished with stainless steel models, and slotted buckets (Fig. 8D) with A.R.C. models. Perforated models have 1/4" round holes on 1/2" centers and will provide superior solids retention.

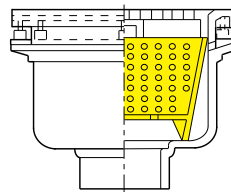

Fig. 8C
Perforated Sediment Bucket

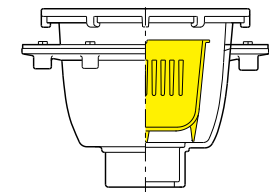

Fig. 8D
Slotted Sediment Bucket

Solid Bottom Ported Buckets: Are particularly suitable for special applications such as can washing, dairy, creamery and potato peelings drains. The bottom portion of the bucket is solid except for four 1/4" drain holes which drain the bucket at the end of a discharge cycle. A ported opening or area is provided at the top of each side of the bucket. Stainless steel buckets (Fig. 8E) are perforated with 1/4" holes on 1/2" centers. Aluminum buckets (Fig. 8F) have ports which are lined with 1/8" mesh stainless steel screen. With this type of bucket, even small solids in suspension will settle to the bottom of the bucket and be retained. This prevents any possibility of line stoppage.

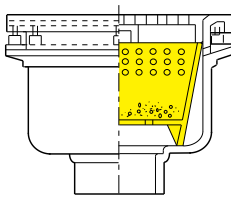

Fig. 8E
Solid Bottom Ported Bucket
with Perforated Ported Area

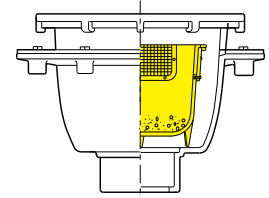

Fig. 8F
Solid Bottom Ported Bucket
with Mesh Lined Ports



• Selection of Tops

TOP GRATES & COVERS FOR TRAFFIC AREAS

When drain tops are subject to traffic loading, they are considered floor and area drain applications. SANI-CEPTOR drains are regularly furnished with light duty top grates as indicated by the basic figure number. Top grates are available for medium, heavy and extra heavy duty service in accordance with ASME/ANSI recommendations shown on page 2-04. To indicate optional top grates or solid covers, simply add desired suffix number.

When drains are to be installed in pedestrian traffic areas such as public walkways, tunnels, airports, bus and train terminals, public garages, shopping centers, malls, plazas, etc., particular care must be exercised in selecting a grate with ample free area for the anticipated drainage. Smith also recommends that, for this service, drains with sediment buckets and optional bottom strainers be selected. Their use will prevent many wasteline stoppages.

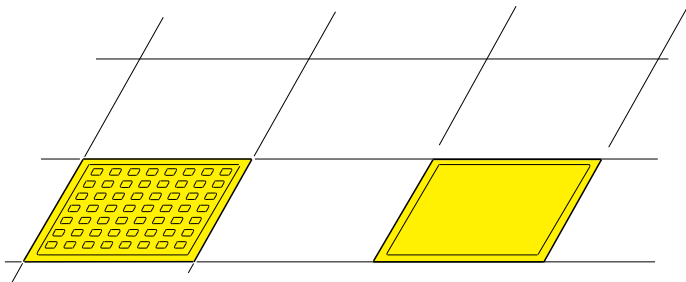

Fig. 9

Fig. 10

Solid covers prevent entry of foreign materials when the drain is out of service. They are ideal in locations where use may be intermittent, seasonal or where future use is anticipated. Solid covers may be replaced with a grate at any future time or, conversely, existing drain grates may be replaced with solid covers.

TOP GRATES & COVERS FOR NON-TRAFFIC AREAS

When drains are installed in areas where they are not subject to pedestrian or other traffic, these are usually indirect waste receptor drain applications. The basic use is the receptor/body, either stainless steel or A.R.C. cast iron, less top (Fig. 11) or A.R.C. body with nickel bronze top less grate (Fig. 12). When there is danger of debris entering the receptor, the use of sediment buckets (Fig. 8C-8F) or recessed grate (Fig. 13) should always be considered. The unique shallow design of recessed grates assures easy removal, where restricted head room precludes the use of a sediment bucket. Recessed grates should always be considered for installation beneath counters in bars and restaurants to intercept pits, bottle caps and similar debris regularly encountered in this service. The unique offset handle provided on the stainless steel models facilitates easy removal and replacement.

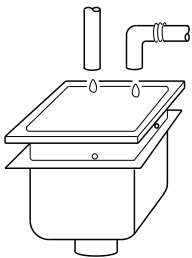

Fig. 11
Less Top
(Suffix -10)

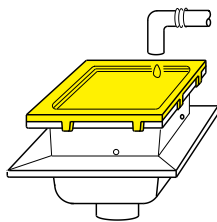

Fig. 12
With Rim Less Grate
(Suffix -11)

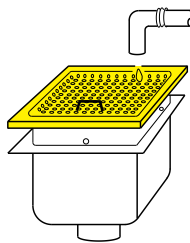

Fig. 13
Recessed Grate
(Suffix -15)

For applications where there is danger of someone stepping into the open top of the receptor, the Smith SANI-CEPTOR line includes half grates (Fig. 14) and three-quarter grates (Fig. 15) and grates with center hole (Fig. 16). These allow the indirect waste to be discharged into the open portion, preventing splashing while protecting balance of the top area with grating.

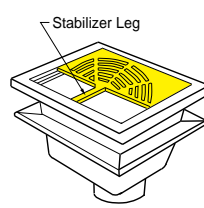

Fig. 14
1/2 Grate
(Suffix -12)

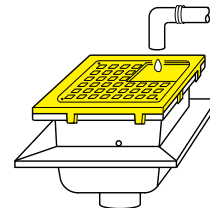

Fig. 15
3/4 Grate
(Suffix -13)

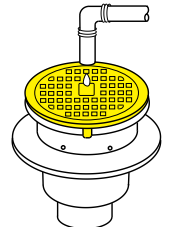

Fig. 16
Center Hole Grate
(Suffix -14)

Half grates (Fig. 17) are particularly suitable for installation beneath frozen food, fruit, vegetable and meat cases. They are installed with the half grate exposed in the toe space and the indirect waste half concealed beneath the case. Smith half grates are either secured or designed to be stable. The unique stabilizing leg (Fig. 14), for example, on A.R.C. half grates prevents the half grate from sliding out of place. Angle grates (Fig. 18) are a variation for modern restaurant designs that incorporate a curb which supports "off the floor" stools and service counter. Both installations provide a sanitary floor drain accessible from the aisle for cleaning by removing the exposed grate with the indirect waste half concealed by the case or counter.

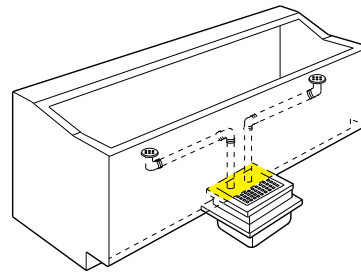

Fig. 17
1/2 Grate (Suffix -12)

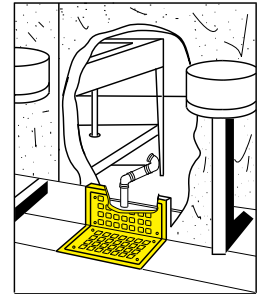

Fig. 18
Angle Grate (Suffix -18)

Partial solid covers are available in place of half grates, three-quarter grates and grates with center hole. They should always be used in lieu of grates when the indirect waste receptor will not be utilized as a floor drain, because they prevent the entry of foreign materials. Solid covers should also be used when the velocity of the indirect waste flow is sufficient to cause splashing up through a grate. The solid cover with center hole (Fig. 19) is particularly desirable when steam or hot water is being discharged with cabinetry installed overhead. This could result in a water vapor which can cause dry rot and mildew in the cabinetry. The solid cover condenses the vapor within the receptor, greatly reducing the potential for damage.

Hinged grates (Fig. 20) are another particularly useful variation. They permit easy access for cleaning the receptor and for emptying sediment buckets. Since the grate is permanently attached to the rim, any possibility of the grate not being replaced by maintenance personnel is eliminated.

The use of funnels on top of SANI-CEPTORS is very popular. For an illustration of the available funnels, please refer to catalog page 3-18. The Smith method of mounting the funnel allows it to be centered on the grate or placed in any other desired location. Round funnels (Fig. 23) are used for single pipe discharge. The 4" diameter is suitable for low velocity. The 6" diameter should be used where higher velocity is anticipated. Oval funnels (Fig. 24) are used for multiple pipe discharge. The 4 1/2" high models should always be used where higher velocity is anticipated.

The use of these funnels with the Smith SANI-CEPTOR prevents splashing of the discharged waste, allows the exposed portion of the grate to function as a floor drain and more importantly, retains the sanitary features of the SANI-CEPTOR. **To specify, simply refer to Optional Top Grates and Covers. Then select the suffix number for the grate shown with the funnel desired.**

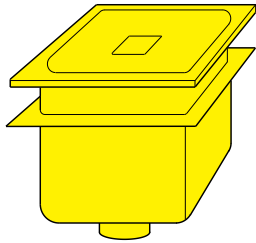

Fig. 19
Solid Cover w/Center Hole
(Suffix -44)

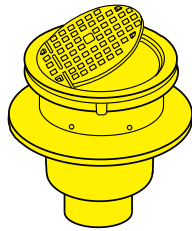

Fig. 20
Hinged Grate
(Suffix -19)

SHAPE OF TOP GRATES AND SOLID COVERS

Sani-ceptor top shape is often influenced by the floor material surrounding the drain. **Round tops** are easiest to orient in many floors since they will not conflict with most floor designs or require alignment with adjacent walls. **Square and Rectangular tops** (Figs. 21 and 22) are particularly useful when installed in floors finished with ceramic tile or vinyl floor coverings. **Rectangular tops** are desirable adjacent to walls because they give the maximum amount of drainage with the minimum amount of projection into the traffic area.

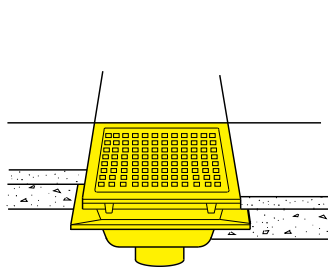

Fig. 21

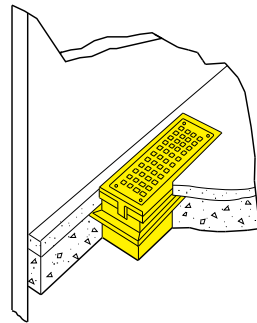

Fig. 22

• Selection of Special Application Items

Dairy drains for quarry tile floors. Quarry tile is often chosen for use in dairies, creameries, breweries and similar food processing installations because of its smooth durable surface. Milk and brewery residue retained by rough surfaces, crevices and pockets common to "regular" floor drains will soon sour. This unsanitary condition fosters bacterial growth and creates undesirable odors. Special A.R.C. coated cast iron dairy drains are available for this service. See catalog page 3-11, Fig. 3110 thru Fig. 3131. **When equivalent stainless steel drains are required,** please refer to catalog page 3-07. Select the desired drain from 3000 or 3000-NB Series and specify the flange to be 3" down from top of drain which is required for quarry tile floors. Then add suffix numbers as desired for top grates or covers and suffix -SBP for solid bottom ported bucket.

Water supply control boxes: Cataloged on page 3-14, are completely vandal proof and ideal to supply hot, cold or tempered water to can washing drains, flushing rim drains or other devices requiring a water supply. They are particularly recommended for installation with:

Smith Can Washing Drains: Fig. 2690 page 2-31 and Fig. 3370 or Fig. 3371 page 3-14.

Smith Refrigerator Drains: Fig. 3365 page 3-13.

Smith Flushing Rim Drains: Fig. 2500 Series page 2-24.

Other Appliances & Devices: Which require hot, cold or tempered water supply.

FUNNEL-CEPTORS®



These are regular floor drains and should not be confused with the Smith SANI-CEPTOR with funnel, because the very features which make FUNNEL-CEPTORS outstanding as regular floor drains, such as adjustable strainer heads and adjustable tops, make it impossible to eliminate pockets and crevices. That reason, we do not recommend them with acid resistant coated interior.



Fig. 23

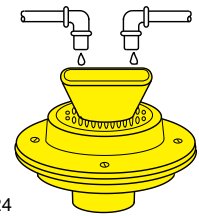

Fig. 24

The advantage of this type drain is that the funnel prevents splashing of the discharged waste, while the exposed portion of the grate functions as a floor drain. The Smith method of mounting the funnel allows it to be centered on the grate or placed in any other desired location. Round funnels are used for single pipe discharge (Fig. 23). Oval funnels are usually used for multiple pipe discharge (Fig. 24). **Should these drains be used to receive indirect waste from food handling equipment, we recommend that they be specified with galvanized body, as this gives the maximum in sanitation for this type of drain.**

FIXED AIR GAPS

The fixed air gap fitting provides a rigid connection to the waste system through a properly sized air gap. One application is for use in the waste line below fixtures which require protection from contamination such as vegetable or food preparation sinks (Fig. 25). If a sewer back-up occurs, the discharge will flow out onto the floor, thus preventing contamination of the fixture. Fixed air gaps are also used when connecting a potable water supply to process equipment or appliances such as the water supply to a tank which contains contaminated liquid. The air gap prevents contaminated liquid backflow into the potable water supply.

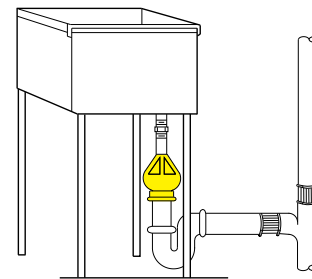

Fig. 25 Fixed Air Gap

ROOF-CEPTOR®

These are indirect waste receptors designed expressly to conform to the requirements of plumbing codes which do not permit the condensate and waste flow from roof mounted refrigeration and other equipment to be discharged onto the roof area (Fig. 26). **Design includes a high collar which prevents rainwater from entering the receptor and a secured strainer which eliminates the possibility of accidental removal and subsequent line stoppage.** ROOF-CEPTORS are installed the same as a regular roof drain, except under conditions in which plumbing codes may require that the receptor be provided with a trap. **Accessories for installation are the same as for roof drains, and the type used depends on the type of roof construction. Please refer to Roof Drain Section for details.**

Fig. 26

