



INTERCEPTORS TECHNICAL DATA

GREASE INTERCEPTORS

APPLICATION: Grease Interceptors are necessary where grease, oils and fats (FOG) are present in kitchen waste-water that must be disposed of through the sanitary sewer system.

Preventing grease from entering the drainage lines should always be considered when designing the plumbing drainage system in any restaurant, cafeteria, hotel, school, hospital, institutional or commercial facility having facilities for preparation and serving of food in quantity. In these installations, as well as in commercial food processing plants, dairies, and other commerce where FOG is a by-product, an efficient SMITH interceptor should be installed to prevent this material from entering the drainage system.

HOW THE INTERCEPTOR OPERATES: Liquid flowing into the interceptor passes through a flow control fitting or orifice plate, which regulates the velocity of the liquid to the capacity of the interceptor. As the water enters the interceptor at this controlled rate of flow, it is free of turbulence. It then passes over a series of separator baffles, which are strategically located to insure that the FOG is efficiently separated from the wastewater. Once separated, these contaminants rise to the surface of the liquid in the interceptor by natural flotation and are accumulated until removed. The wastewater, now relieved of over 90% of the contaminant FOG, continues to flow through the interceptor into the sanitary system.

PROCEDURE FOR SIZING GREASE INTERCEPTORS

EXAMPLE

STEP 1	Determine the cubic content of the fixture by multiplying length x width x depth.	A sink 48" (1219mm) long by 24" (610mm) wide by 12" (305mm) deep- Cubic content 48 x 24 x 12 = 13,824 Inches ³ (226,535mm)
STEP 2	Determine the capacity in gallons (Liters). 1 gallon (3.785L) = 231 Inches ³ (3785cm ³)	$\frac{13,824 \text{ Inches}^3 (226,535 \text{ cm}^3)}{231 \text{ Inches}^3 (3785 \text{ cm}^3)} = 59.8 \text{ gallons. (226 L)}$
STEP 3	Determine actual drainage load. The fixture is usually filled to about 75% of capacity with waste water. The items being washed displace about 25% of the fixture content. Actual drainage load = 75% of fixture capacity.	Actual Drainage Load = .75 x 59.8 gallons (226 L) = 44.9 gallons (170 L)
STEP 4	Determine the flow rate and the drainage period. In general, good practices dictate a one minute drainage period, however where conditions permit, a 2-minute period is acceptable. Drainage period is the actual time required to completely empty the fixture. Flow Rate = $\frac{\text{Actual Drainage Load}}{\text{Drainage Period}}$	Calculate flow rate for 1-minute period. Flow Rate = $\frac{44.9 \text{ gallons (170 L)}}{1\text{-Minute}} = 44.9 \text{ GPM (170 L/min)}$ For 2 minute period Flow Rate = $\frac{44.9 \text{ gallons (170 L)}}{2\text{-Minutes}} = 22.5 \text{ GPM (85 L/min)}$
STEP 5	Select the Interceptor which corresponds to the flow rate calculated. Note – Select larger size when flow rate falls between two sizes listed.	For 1-minute period 44.9 GPM (2.83 L/S) requires a 50 GPM (189 L/min) unit, For 2-minute period 22.5 GPM (1.42 L/S) requires a 25 GPM (75 L/min) unit.

TYPICAL SINGLE FIXTURE INSTALLATIONS

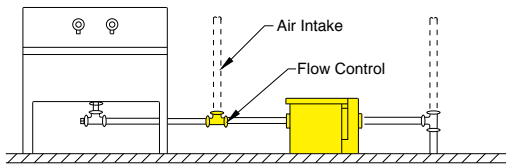

FIXTURE NOT TRAPPED

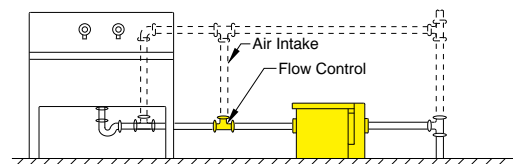

FIXTURE TRAPPED AND VENTED SEPARATELY

As a general rule, it is good practice to size the Interceptor so that its rated capacity is never less than 40% of the fixture capacity in gallons. In the example above, the actual fixture capacity is 59.8 gals., and 40% of this would be 23.9 gals. or a Fig. 8025. Using the 40% rule of thumb gives a drainage period of 1-7/8 minutes. A drainage period longer than 2 minutes is not recommended.

AUTOMATIC DRAW-OFF GREASE INTERCEPTORS



Smith "GT" Series Automatic Draw-off Grease Interceptors offer the same high intercepting efficiency as the conventional manual cleaned models, but completely eliminate the unsanitary and undesirable job of removing the accumulated grease manually.

- The automatic draw-off interceptor eliminates . . .
- time consuming cover removal
 - manually removing accumulated grease
 - offensive odors

Since cleaning a "GT" interceptor is simple, fast and efficient, maintenance personnel will more likely follow the regular cleaning schedule. This is a distinct advantage over the conventional units which are frequently left unattended.

When to Clean - The ideal time to clean is immediately after the interceptor has been heavily used.

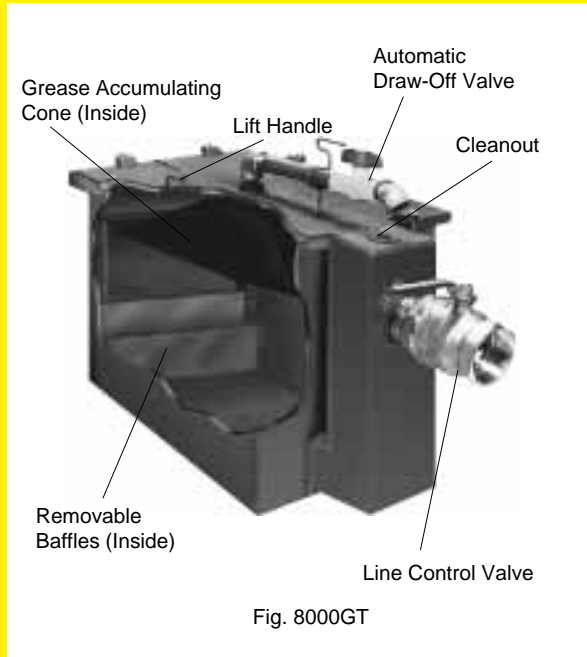

Fig. 8000GT

Cleaning Frequency - The frequency of the draw-off cycle is determined by the use load factor of the interceptor. An ideal cleaning cycle can be set after the unit is in operation for several weeks. By observing the amount of grease used and the frequency of use, the operator can determine a logical cleaning cycle.

Cleaning Operation 8000 GT Series

1. Unit in normal use has the line control valve open and automatic draw-off valve closed. When cleaning is required, run a full stream of hot water through interceptor. It is preferable to have this water at 140° or higher, running for a period of at least two minutes.
2. Turn off hot water running into the interceptor and wait for a period of three to five minutes for grease in the interceptor to liquefy.
3. Automatic draw-off cycle can now be started. Close the line control valve.
4. Open automatic draw-off valve at top of the interceptor and place a container underneath this valve. Run hot water through interceptor at a rate of between 1 1/2 and 2 1/2 G.P.M.
5. After water has run into interceptor at this rate for a short period, the unit will fill. Accumulated liquefied grease will be raised into cone and draw-off piping.
6. Allow accumulated liquefied grease to flow out of draw-off valve until clear water appears.
7. When clear water appears, shut off flow of hot water into interceptor, turn line control valve to open position. Close automatic draw-off valve at top of interceptor.
8. Interceptor at this stage is ready again for normal use.

INSTALLATION - GREASE INTERCEPTORS

MULTIPLE FIXTURE INSTALLATIONS

It is sometimes practical to discharge the waste from two or more sinks into a single Interceptor. This practice is only recommended when all fixtures are close together, avoiding installation of long piping runs to the Interceptor. For multiple installations, size as follows:

1. Determine total capacity of all sinks.
2. Establish the maximum simultaneous discharge of the sinks and fixtures.
3. Using the maximum simultaneous load capacity, determine the Interceptor required using the sizing method shown on page 8-01.

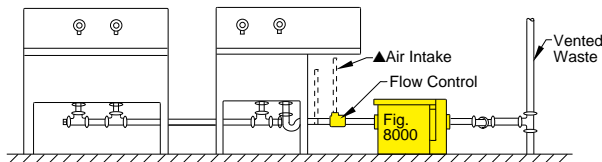

ON FLOOR INSTALLATION

▲ Terminate Air Intake outside above the rim of sink with return bend or connect to vent or vent stack as required by local code.

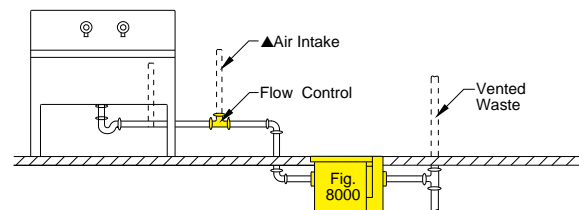

SINGLE INSTALLATION - FULLY RECESSED

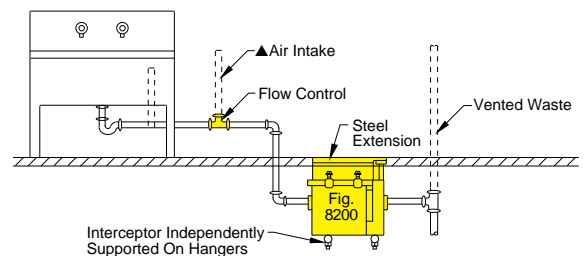

RECESSED WITH EXTENSION TO FLOOR LEVEL

Interceptor cover may be brought to floor level by using an extension when Interceptor installation is below the floor.

GREASE INTERCEPTORS WITH EXTENSION INSTALLATION NOTE

The Extension of 8200 Series Interceptors is designed to increase the roughing dimension from the Inlet-Outlet center line to the finished floor. The Extension should not be used to support the entire unit. When installed in ground floor locations, the Interceptor body must rest on solid ground or on a suitable concrete pad. If the 8200 Series unit is installed in an upper floor (suspended in the ceiling below), a suitable method of supporting the entire unit must be provided. The installation sketch shows a typical Interceptor with Extension and a recommended method of supporting the entire weight.

SUSPENDED INTERCEPTOR INSTALLATION CONSIDERATIONS

Whenever an interceptor is to be installed suspended with receiving cradle (8300 series) or independently (all other series interceptors), proper support is essential for safety and functional integrity of the installation.

Trapeze type hangers such as those employed for support of multiple runs of horizontal piping are recommended for support of independent interceptors. Such supports should also be considered for 8300 series receiving cradles to supplement the integral concrete anchor flange. Supports must be of sufficient strength for the purpose intended and meet with the approval of the architect or engineer.



FLOW CONTROL FITTING

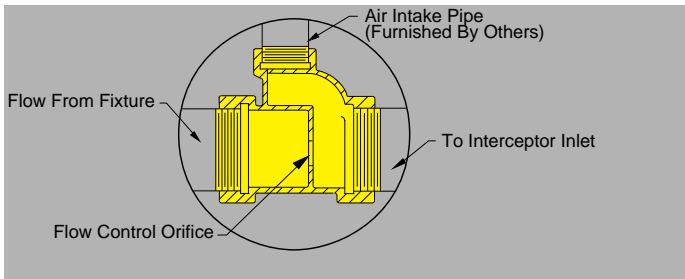

DISHWASHER MACHINES

A separate grease Interceptor is recommended with each dishwashing machine. The size of the Interceptor is determined by the dishwasher capacity.

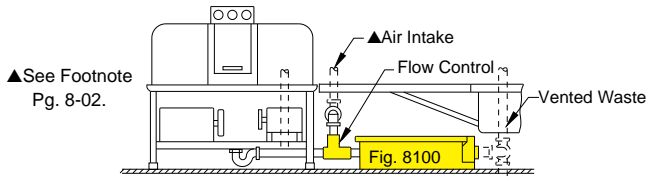

LOW TYPE - DISHWASHER INSTALLATION

Dishwasher Capacity	Gals.	15-20	20-30	30-50	50-70	70-100
Interceptor Size	Fig.	8015	8020 8120	8025	8035 8135	8050 8150

MAINTENANCE

All interceptors must be cleaned regularly. The frequency of grease removal is dependent upon the capacity of the interceptor and the quantity of grease in the waste water. The cleaning interval can vary from once a week to once in several weeks. When this period is determined, we recommend regular cleaning at this interval in order to maintain proper operating efficiency. Solids that collect in the interceptor through settling should also be removed at the same time of the grease removal. At this time the air relief port should be checked to see that it is clear. Complete operating and maintenance instructions are packed with every interceptor.

OIL INTERCEPTORS

An oil interceptor is required wherever lubricating oil, cutting oil, kerosene, gasoline, naphtha, paraffin, trisodium phosphate and numerous other light density and volatile liquids are present in the drainage system.

In commercial establishments such as service stations, garages, auto repair shops, dry cleaners, laundries, industrial plants or process industries having machine shops, metal treating process rooms, chemical process or mixing rooms, etc., there is always the problem of flammable or volatile liquids entering the drainage system which can contaminate the sewer line and cause a serious fire or explosive condition.

Oil interceptors are designed to separate oils and other light density volatile liquids which are discharged into the drainage system.

The interceptor is installed between the drain and the sanitary system so the liquids passing through the interceptor are trapped and separated by gravity through a baffle arrangement and are then diverted to an accumulator chamber and removed through the gravity draw-off built into the interceptor. This draw-off can be piped directly to a storage tank so the interceptor continuously and automatically drains the accumulated oils.

Each Oil Interceptor is furnished with a sediment bucket which collects chips, particles or other sediment frequently present in industrial waste that could clog the drainage system. A gasketed removable cover provides access for cleaning the interceptor. To eliminate pressure build-up inside the interceptor, a vent connection on each side of the body allows the venting of the interceptor.

A SMITH Oil Interceptor is sized in accordance with maximum anticipated gallon per minute flow rate of water that would be discharged through the drains it serves. A flow control fitting of the exact gallon per minute interceptor rating insures maximum oil interception efficiency.

OIL INTERCEPTOR INSTALLATION EXAMPLE

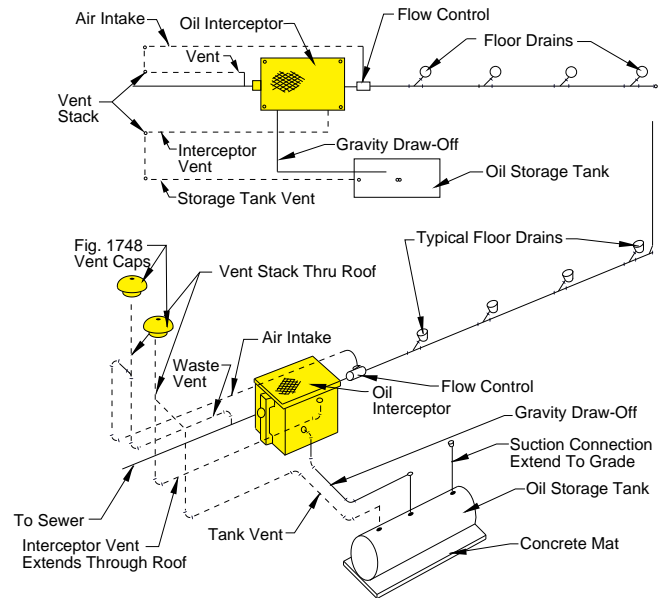

INSTRUCTIONS FOR ADJUSTING GRAVITY OIL DRAW-OFF

When the Interceptor is completely installed, establish operating water line by running water thru interceptor at maximum flow rate. Mark or locate this operating water line and adjust tubing 1/8" above this line as shown in Detail "A". Adjustment should be checked after Interceptor is in operation. If water is present in oil removed through gravity draw-off, adjustable brass tube should be raised slightly, until no water is present.

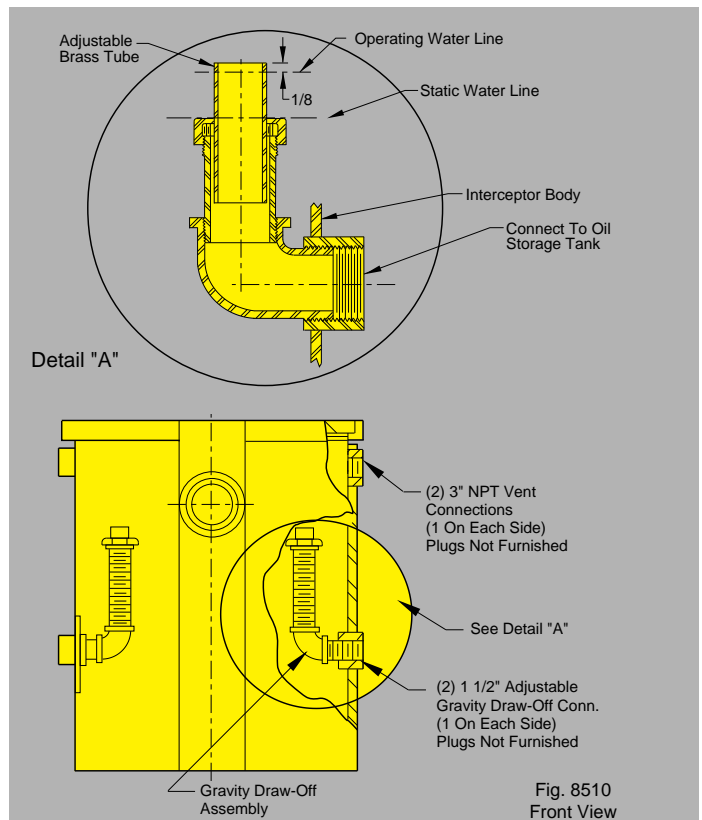

APPROVED BY N.Y. BOARD OF STANDARDS AND APPEALS NO. 935-53-SM