

Jay R. Smith Mfg. Co.®

Rainwater Harvesting Products

Rainwater Harvesting
Filters and Storage
Tank Components
for All Roof Areas.



In Cooperation with WISY AG and Rainwater Management Solutions (RMS)
- The Leaders in Rainwater Products and Consulting.

INDEX

Rainwater Harvesting Overview and Sustainability.....	1
Rainwater Harvesting Steps: Collection, Conveyance and Storage	2-3
Rainwater Harvesting: Advantages and Benefits	4
Industrial, Commercial, Military, and Residential Applications of Rainwater Harvesting.....	5
The Rainwater Re-Use Process, A Commercial Application Illustration.....	6-7
PRODUCT SELECTION	
SIPHONIC ROOF DRAINS.	8
Siphonic Roof Drain - 15 1/4" Dia.	8
Siphonic Gutter Drain - 6" Dia.....	8
RAINWATER FILTERS	9-13
Inline Downspout Garden Filter Collection - 1,000 Square Foot Roof Area	9
Inline Downspout Filter Collector - 1,600 Square Foot Roof Area	9
Standpipe Downspout Filter Collector - 2,000 Square Foot Roof Area.....	10
4"-6" Outlet Vortex Rainwater Fine Filters - 2,200 and 5,500 Square Foot Roof Area	11-12
12" Outlet Vortex Rainwater Fine Filter - 32,000 Square Foot Roof Area.....	13
STORAGE TANK COMPONENTS	14
Storage Tank Providers.....	14
Smoothing Inlet	14
Storage Tank Floating Filters and Hoses	14
Four Steps to a Sustainable Rainwater Harvesting System - Illustration	15
Components of Rainwater Harvesting System Packages.	16
Selecting a Rainwater Harvesting Package by Roof Area	16
RAINWATER HARVESTING PACKAGES FOR ROOF AREAS UP TO 5,500 SQUARE FEET	
PACKAGE 1: In-Line Above Grade Garden Package for Roof Area Up to 1,600 Sq. Ft	17
PACKAGE 2: Standpipe Below Grade Package for Roof Area Up to 2,000 Sq. Ft	18
PACKAGE 3: In-Line Above Grade Package for Roof Area Up to 1,600 Sq. Ft.	19
PACKAGE 4: Above Grade Package for Roof Area Up to 5,500 Sq. Ft	20
PACKAGE 5: Above Grade Potable Package for Roof Area Up to 5,500 Sq. Ft	21
PACKAGE 6: Above Grade Package for Roof Area Up to 2,200 Sq. Ft.	22
PACKAGE 7: Below Grade Potable Package for Roof Area Up to 5,500 Sq. Ft	23
RAINWATER HARVESTING PACKAGE COMPONENTS	24-25
Storage Tank Overflow Device.....	24
Sensor Type Storage Tank Level Indicator	24
Purification Kit	24
Suction/Booster Pump	25
Float Switches.....	25
How Do I Calculate How Much Rainwater Can Be Harvested.....	25
 LEED® / Green Building Design - A Green Idea	 Back Cover



Rainwater Harvesting - Overview

Rainwater harvesting is a technology used to collect, convey and store rain from relatively clean surfaces such as a roof for later use. This is water that would otherwise have gone down the drainage system or into the ground. The water is generally stored in a rainwater tank or directed into mechanisms that can recharge groundwater. Rainwater harvesting can provide water for human consumption, reduce water bills and lessen the need to build reservoirs which may require the use of valuable land.

Rainwater harvesting has been practiced for over 4,000 years throughout the world. It has provided drinking water, domestic water, water for livestock, water for small irrigation and a way to replenish ground water levels. Traditionally, rainwater harvesting has been practiced in arid and semi-arid areas. It has become an integral part of societies in remote places where piping water and reliance on wells is not an option.

Rainwater harvesting in urban areas and cities can have diverse benefits. Providing supplemental water for the city's requirements, increasing soil moisture levels for urban greenery, increasing the ground water table through artificial recharge, mitigating urban flooding and improving the quality of groundwater are a few of the many benefits. In homes and buildings, collected rainwater can be used for irrigation, flushing toilets and washing laundry. In hard water areas rainwater is superior to city water for non-potable use. With proper filtration and treatment, harvested rainwater can also be used for showering, bathing, or drinking.

Rainwater harvesting is also effective in reducing stormwater runoff pollution into the watershed. When rain falls, it is clean, but it immediately picks

up pollutants from rooftops and pavement. This pollution is carried into storm drains and then into streams. Collecting stormwater from rooftops and directing it to storage tanks so it can be used in and around a building decreases the volume and rate of stormwater runoff, thus protecting local bodies of water from pollutants.



Sustainability

Rainwater harvesting is one of the most promising alternatives for supplying water in the face of increasing water scarcity and escalating demand. The pressures on water supplies, greater environmental impact associated with new projects as well as deteriorating water quality in reservoirs already constructed, constrain the ability of communities to meet the demand for freshwater from traditional sources. Rainwater harvesting presents an opportunity for augmentation of water supplies allowing for self-reliance and sustainability. Sustaining the environment contributes to the overall conservation of our precious natural resources.



Rainwater Harvesting: Co

The Collection, Conveyance and Storage of Rainwater for Later Use

Commonly, rainwater harvesting systems are constructed of three primary segments; (1) a collection method, (2) a conveyance component and (3) a storage facility. Rainwater harvesting collection, conveyance and storage systems can be incorporated into almost any existing building, although it is easier to incorporate a rainwater harvesting system into new construction.

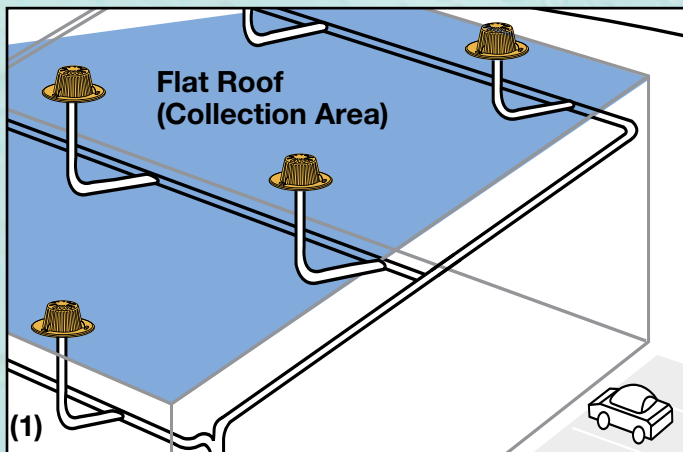

(1) A collection or catchment system is a simple structure comprised of roofs and/or gutters that direct the rainwater through a conveyance system and into a storage container. Roofs are ideal as catchment areas as they easily collect large volumes of rainwater. The amount and quality of rainwater collected from a catchment area depends upon the rain intensity, roof surface area and type of roofing material. For a 1,000 square foot roof, about 620 gallons of rainwater can be collected, per inch of rainfall, regardless of pitch.

(2) Conveyance components are required to transfer the rainwater from the roof catchment to

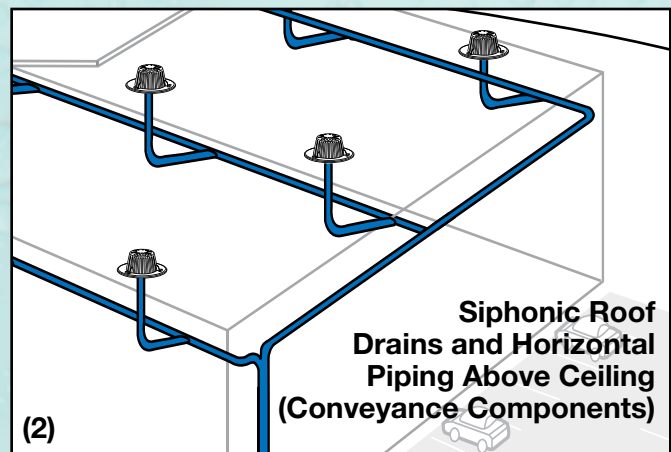

storage. Conveyance is usually accomplished by connecting roof drains and piping from the catchment area (or roof top) to one or more downspouts that transport the rainwater through a filter system to storage in tank or retention pond for reuse or recharge.*

A siphonic roof drainage system is one of the most effective technologies offered for capturing rainwater from a building roof top to aid in implementing rainwater harvesting. In a siphonic system several roof drain outlets can be connected to a single vertical discharge pipe. Fewer discharge points and no requirement for pitch in the piping means the rainwater can be easily routed horizontally below the roof to a storage tank or retention pond.

*Conventional gutters and downspouts are recommended for conveying rainwater on small businesses, homes, and other buildings or structures where a conventional (gravity) or Siphonic Roof Drain System is not practical.

Collection, Conveyance and Storage

One of the major benefits of designing a building with siphonic roof drainage and rainwater harvesting systems is reduced overall construction and facility operation costs. Additional benefits include reduced discharge of rainwater to lakes, streams, rivers and sanitary systems, and decreased dependence on municipal water supplies. For more information about Siphonic Roof Drains contact your local Jay R. Smith Mfg. Co. representative or visit www.jrsmith.com.

include cylindrical ferrocement tanks (reinforced steel and concrete), mortar jars (large jar shaped vessels constructed from wire reinforced mortar), single and battery (interconnected) tanks made of either galvanized steel, concrete, ferrocement, fiberglass, or polyethylene, or they could be made of wood, metal, or earth. Storage tanks should be located as close to supply and demand points as possible to reduce the distance the water is conveyed.

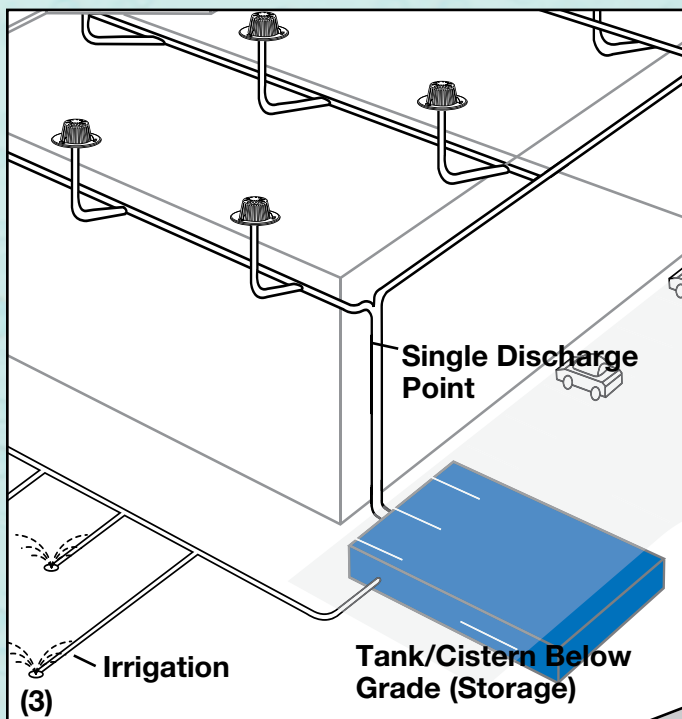

(3) Storage tank (or cisterns) for the harvested rainwater make stored rainwater available when needed. Depending on the space available these storage containers can be constructed above grade, partly underground, or below grade. Various types of rainwater storage containers can be found in use. They

The size of the storage container needed for a particular application is determined by the amount of water available for storage (a function of roof size and local rainfall), the amount of water likely to be used (a function of demand), and the projected length of time without rain, aesthetics, and budget.

Before water is stored in a storage tank (or cistern), and prior to use, it should be filtered to remove particles and debris. Filtration is a key element in the storage and use of harvested rainwater. Upon leaving the tank, the stored water is extracted from the cleanest part of the tank, just below the surface of the water, using a floating filter.

Considerations for Fitting a Rainwater Collection System:

1. The drainage from the roof needs to be directed to bring water to a central point.
2. Access to the tank and excavation is required.
3. Internal plumbing requires rainwater to be identified and kept separate from other water sources.



Rainwater Harvesting: Advantages and Benefits

Advantages of Rainwater Harvesting

Rainwater harvesting systems are simple to install, operate, and maintain. It is convenient in the sense that it provides water at the point of consumption and operating costs are negligible. Water collected from the roof catchment is available for use in potable (per local approval) and non-potable applications such as toilet and/or urinal flushing, laundries, mechanical systems, custodial uses, and site irrigation. Since rainwater is collected using existing structures, i.e., the roof, rainwater harvesting has few negative environmental impacts.

Benefits of Using Rainwater:

1. It is free; the only cost is for installation and use.
2. It lessens demand on the municipal water supply.
3. It saves money on utility bills.
4. It makes efficient use of a valuable resource.
5. It diminishes flooding, erosion, and the flow to stormwater drains.
6. It reduces the contamination of surface water with sediments, fertilizers and pesticides from rainwater run-off resulting in cleaner lakes, rivers, oceans and other receivers of stormwater.
7. It can be used to recharge groundwater.
8. It is good for irrigation and plants thrive because stored rainwater is free from pollutants as well as salts, minerals, and other natural and man-made contaminants.
9. It is good for laundry use as rainwater is soft and lowers the need for detergents.
10. It adds life to equipment dependent on water to operate, as rainwater does not produce corrosion or scale like hard water.
11. It can help achieve LEED® Green Building Credit under Water Use Reduction; Innovative Wastewater Technology; Stormwater Design: Quality Control; Stormwater Design: Quantity Control; Water Efficiency Landscaping; and Innovation in Design.

Did you know: A rainwater system along with other sustainable systems can increase the value of a building.

United States Green Building Council



Industrial, Commercial, Military, Residential and Supplemental Benefits of Rainwater Harvesting:

Benefits	Uses	Industrial Application	Commercial Application	Military Application	Residential Application
Water Conservation	Site Irrigation, Lawn & Garden	•	•	•	•
	Toilet and/or Urinal Flushing	•	•	•	•
	Janitorial Use	•	•	•	
	Laundry	•	•	•	•
	Filling Pools and Hot Tubs				•
	Fire Protection, Reduce Insurance Cost	•	•	•	•
Reduced Municipal Water Consumption	Fleet and/or Car Wash	•	•	•	•
	Commercial Laundry	•	•	•	
	Process Water	•	•	•	
	Evaporative Cooling Tower	•	•	•	
	Mechanical Equipment	•	•	•	
	Reduces Monthly Water Bills	•	•	•	•
	Avoids Water Restrictions	•	•	•	•
	Reduces or Eliminates Water Treatment	•	•	•	•
	Adds Value to a Home or Building	•	•	•	•
Stormwater Runoff Reduction	Assists Storm Water Permitting	•	•	•	
	Less Property Use for Site Detention	•	•	•	•
	Contained Storage, Reduces Mosquitos	•	•	•	•
	Decreased Soil Erosion from Runoff	•	•	•	•
	Reduced Flooding from Runoff	•	•	•	•
	Improved Water Quality to Water Sheds	•	•	•	•
Can Offset "Roof Top Taxes" Imposed by Local and State Authorities		•	•	•	
	Promotes Good Public Relations, Showing Positive Environmental Concern	•	•	•	
	Decreases Dependency on Delivered Water Supply	•	•	•	•
	Can Serve as a Water Source if Primary Water Supply is Impacted Due to a Natural Disaster				•
	Redirect Tank Overflow as Groundwater Recharge	•	•	•	
	Can Be Used as a Potable Water Supply				•
	Can Be Used in Developing Areas with Limited Water				•

Typical Commercial Application

Drawing for illustration purposes only.

A Rainwater is collected on the roof.

B The harvested rainwater is conveyed through the roof drains and piping to a single point of discharge.



15 1/4" DIA.,
Siphonic Roof Drain
Fig. # 1005T Male Thread Outlet
1005Y No-Hub Outlet
Page 8

G The extracted rainwater can be used for toilets and urinals, irrigation, mechanical systems, laundries or other non-potable uses.

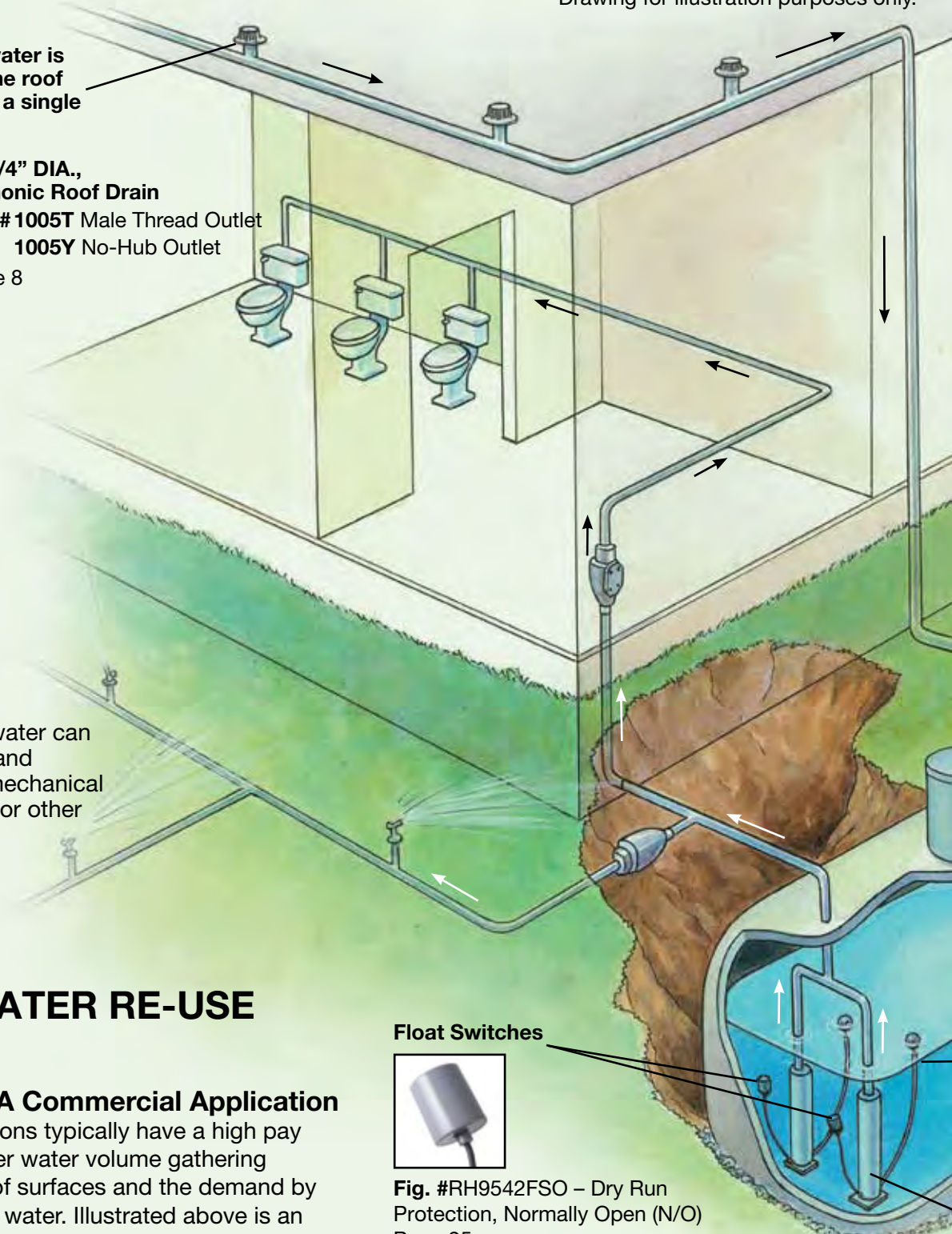

THE RAINWATER RE-USE PROCESS

How It Works In A Commercial Application

Commercial applications typically have a high pay back due to the higher water volume gathering capability of large roof surfaces and the demand by commercial users for water. Illustrated above is an example of how a rainwater harvesting system could be used in a commercial application.

NOTE: During low rainfall events, an alternative make-up water source such as the city or county water system is required to supply the building's water needs. The appropriate backflow preventer assemblies, per the local jurisdiction, are required for this application.

Float Switches



Fig. #RH9542FSO – Dry Run Protection, Normally Open (N/O)
Page 25



Fig. #RH9542FSC – Back-up Water Feed, Normally Closed (N/C)
Page 25



C At the point of discharge, the rainwater is transported through a vortex filter that removes large and fine debris.



Vortex Rainwater Fine Filter for Above or Below Grade Application
Fig. #RH9521-12
Page 13



Smoothing Inlet
Fig. #RH9530SI
Page 14

D From the filter, the collected water enters the storage tank through the smoothing inlet.

Water quality is maintained by removing the organic matter and by the action of incoming water which introduces oxygen. Water that is kept aerobic in this way does not become foul smelling, even when stored for long periods.

Below Grade Storage Tank
(By Others)

E The overflow/backwater device in the tank is designed to skim floating particles from the surface of the water when the storage unit overflows.
(By Others)

F



Storage Tank Floating Filter and Hose
Fig. #RH9532C
Page 14

Harvested water is extracted from the cleanest part of the tank, just below the surface of the water, using a floating filter and pump.

Pumps
(By Others)

SIPHONIC ROOF DRAIN 15 1/4"(390) DIAMETER - LOW PROFILE DOME



Figure Number: 1005T Male Thread Outlet
1005Y No-Hub Outlet

FUNCTION: For use in engineered siphonic roof drainage systems. May be used in flat roof of any construction. The large low profile dome provides sufficient free area for quick drainage of rainwater and protects the drain sump, baffle and connected piping from the intrusion of debris. Internal air baffle creates siphonic drainage action producing a more efficient drainage than traditional roof drains.

Regularly Furnished: Duco Cast Iron Body, Flashing Clamp, Air Baffle and Polyethylene Dome.

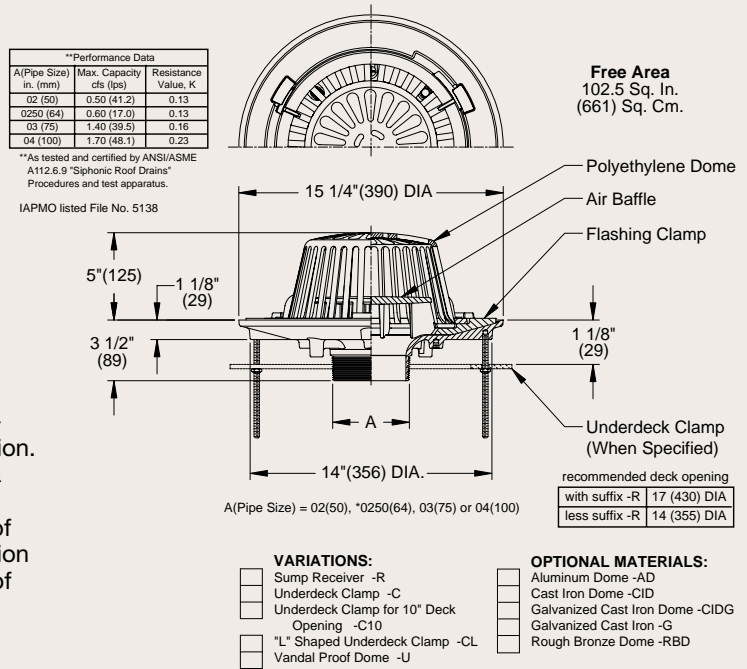

SIPHONIC GUTTER DRAIN 6"(150) DIAMETER - LOW PROFILE GUTTER DRAIN



Figure Number: 1605T with Male Thread Outlet
1605Y No-Hub Outlet

FUNCTION: For use in engineered siphonic roof drainage systems for gutters, parapets, small balconies, sills, cornices, marquees and other small overhanging areas where drainage of rainwater is required. Air baffle creates siphonic drainage action producing a more efficient drainage than traditional gutter drains.

Regularly Furnished: Duco Cast Iron Body with Combination Flashing Clamp and Air Baffle.

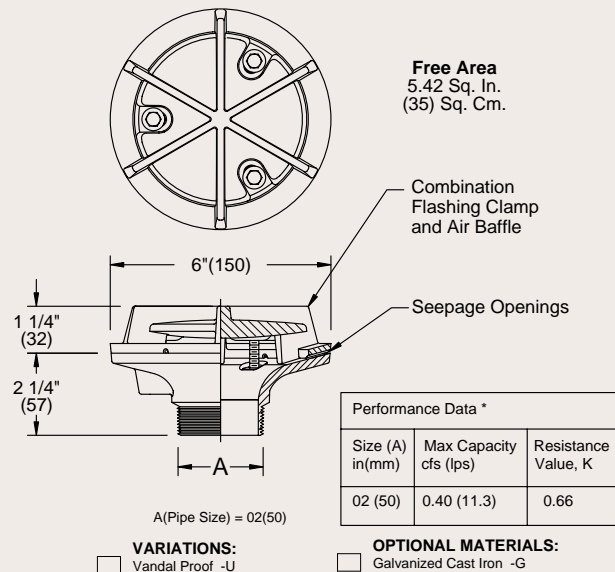

*As tested and certified by ANSI/ASME A112.6.9 "Siphonic Roof Drains" procedures and test apparatus.

IAPMO listed File No. 5138

RAINWATER FILTERS

Rainwater filters are fitted to a downspout between the roof drain/gutter and the storage tank and storm drain system. Filtration diverts or removes most of the initial containments such as leaves, sticks, and other roof debris, that have accumulated on the roof between rainfalls to be diverted away from the storage container. Separating the organic debris from the clean rainwater ensures the stored water quality is not impacted due to anaerobic conditions.

RH9508-04 Inline Downspout Garden Filter Collector for Above Grade Applications for a Roof Area Up to 1,000 Square Feet

Connects to a single vertical rainwater downspout and can filter up to a 1,000 square foot roof area for irrigation, car washing, or other non-potable uses.

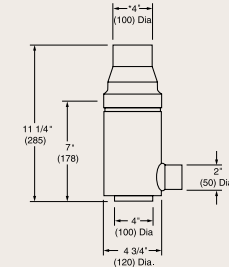

NOTE: Dimensions shown in parentheses are in millimeters.

Figure Number: RH9508-04 – 4” No-Hub Outlet

FUNCTION: Connects to a single vertical rainwater downspout and can filter up to a 1,000 square foot roof area for irrigation, car washing or other non-potable uses. The downspout filter collector is installed above grade in the vertical rainwater down piping to remove debris to the storm water system and divert 90% of the clean rainwater to the storage tank. The filter acts as a first flush device.

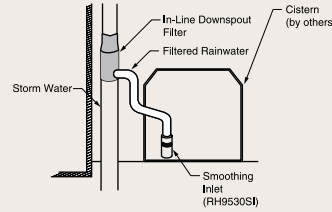

Regularly Furnished:

- Stainless Steel Filter (RH9508-04)
- 280 micron Stainless Steel Fine Mesh Filter (RH9508F)
- Downspout Converter Kit (specify):
 - 2” x 3” Downspout Kit (RH9510DK3)
 - 3” x 4” Downspout Kit (RH9510DK4)

Accessories:

- Blind Insert (RH9508-BI)
Used in place of the mesh filter to divert flow directly to the storm drain system. Stainless Steel.
- 1” Flexible Hose with 2” Connection for Downspout Filter (RH9510TH)
- Downspout Clip with Screw and Wall Plug (RH9510SC)
For securing the filter unit to a wall.



Blind Insert



1” Flexible Hose



Downspout Clip



RH9510-04 Inline Downspout Filter Collector for Above Grade Application for a Roof Area Up to 1,600 Square Feet

Connects to a single vertical rainwater downspout and can filter up to a 1,600 square foot roof area for irrigation, car washing, or other non-potable uses.

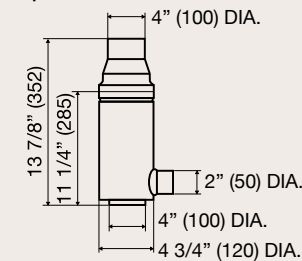

NOTE: Dimensions shown in parentheses are in millimeters.

Figure Number: RH9510-04 – 4” No-Hub Outlet

FUNCTION: The downspout filter collector is installed above grade in the vertical rainwater downspout piping to remove debris to the storm water system and divert 90% of the clean rainwater to the storage tank. The filter operates as a first flush device. The filter assembly consists of downspout converter kit and filter. The stainless steel filter assembly components are the upper housing, 280 micron fine mesh filter, and main housing. The mesh filter is easily removed and should be cleaned in a dishwasher at least twice a year.

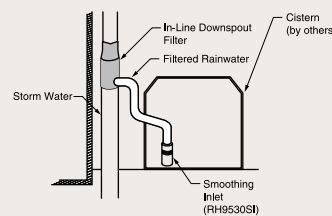

Regularly Furnished:

- Stainless Steel Filter (RH9510-04)
- 280 micron Stainless Steel Fine Mesh Filter (RH9510F)
- Downspout Converter Kit (specify):
 - 2” x 3” Downspout Kit (RH9510DK3)
 - 3” x 4” Downspout Kit (RH9510DK4)

Accessories:

- Blind Insert (RH9510BI)
Used in place of the mesh filter to divert flow directly to the storm drain system. Stainless Steel.
- 1” Flexible Hose with 2” Connection for Downspout Filter (RH9510TH)
- Downspout Clip with Screw and Wall Plug (RH9510SC)
For securing the filter unit to a wall.



Blind Insert



1” Flexible Hose



Downspout Clip



RH9511-04 Standpipe Downspout Filter Collector for Below Grade Application for Roof Area Up to 2,000 Square Feet

Connects to a single vertical rainwater downspout and can filter up to a 2,000 square foot roof area for irrigation, car washing or other non-potable uses. Filter is designed to be partially buried.

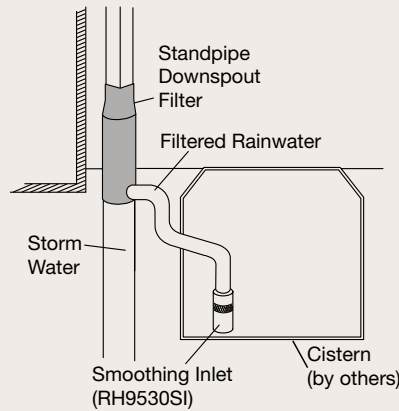
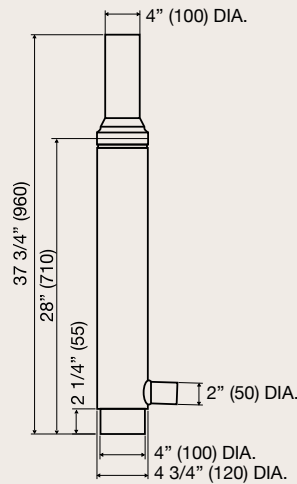

NOTE: Dimensions shown in parentheses are in millimeters.

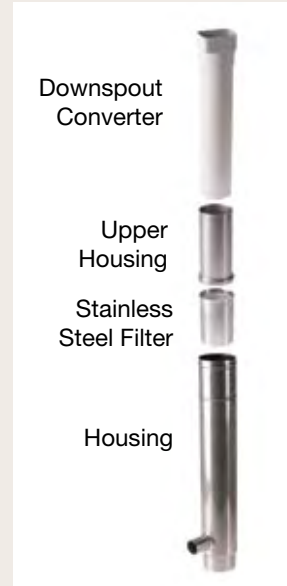

Figure Number: RH9511-04 – 4" No-Hub Outlet

FUNCTION: The standpipe downspout filter collector is installed in the vertical rainwater downspout piping partly below grade to remove debris to the storm water system and divert 90% of the clean rainwater to an underground storage tank. The filter operates as a first flush device. The filter assembly consists of downspout converter kit and filter. The stainless steel filter assembly components are the upper housing, 280 micron fine mesh filter, and main housing. The mesh filter is easily removed and should be cleaned in a dishwasher at least twice a year.

Regularly Furnished:

- Stainless Steel Filter (RH9511-04)
- 280 micron Stainless Steel Fine Mesh Filter (RH9511F)
- Downspout Converter Kit (specify):
 - 2" x 3" Downspout Kit (RH9510DK3)
 - 3" x 4" Downspout Kit (RH9510DK4)

Accessories:

- Blind Insert (RH9510BI)
Used in place of the mesh filter to divert flow directly to the storm water system. Stainless Steel.
- 1" Flexible Hose with 2" Connection for Downspout Filter (RH9510TH)
- Downspout Clip with Screw and Wall Plug (RH9510SC)
For securing the filter unit to a wall.

How the Downspout Filter Collector Works

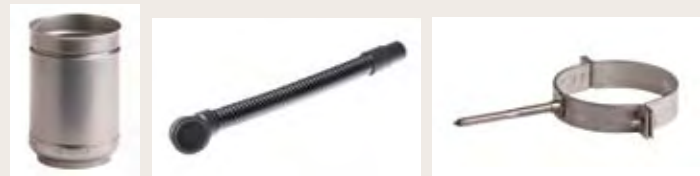
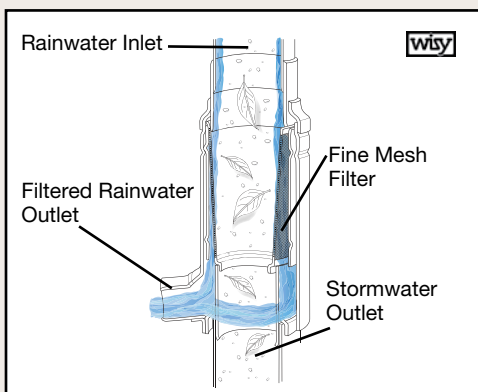

Blind Insert

1" Flexible Hose

Downspout Clip

Efficiency Ratio and Performance Chart

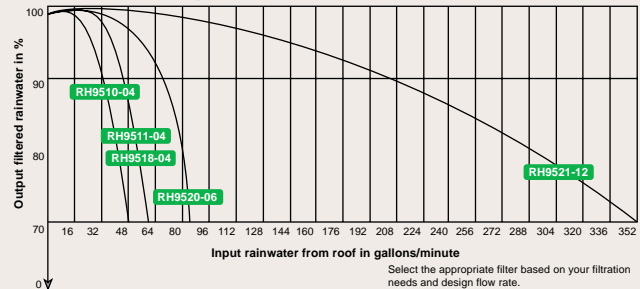

Our filters efficiently recover the rainwater for various flow rates, i.e. for 90% filtered water you can select*:

- RH9510-04 for up to 32 gallons/minute flow rate
- RH9511-04 for up to 42 gallons/minute flow rate
- RH9518-04 for up to 42 gallons/minute flow rate
- RH9520-06 for up to 65 gallons/minute flow rate
- RH9521-12 for up to 208 gallons/minute flow rate

*Efficiency ratio tested with brand new filters



RH9518-04, 4" Outlet - Vortex Rainwater Fine Filter for Above or Below Grade Applications for Roof Area Up to 2,200 Square Feet

Used in installations where multiple downspouts are connected together to a single pipe into the vortex filter. The vortex rainwater filter can filter up to a 2,200 square foot roof area for site irrigation, toilet and urinal flushing, janitorial use, laundries, fire protection, evaporative cooling tower make-up, process water, or other non-potable uses.

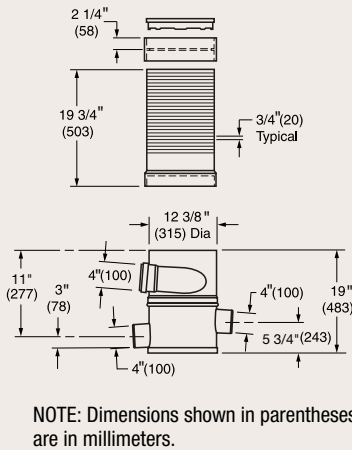
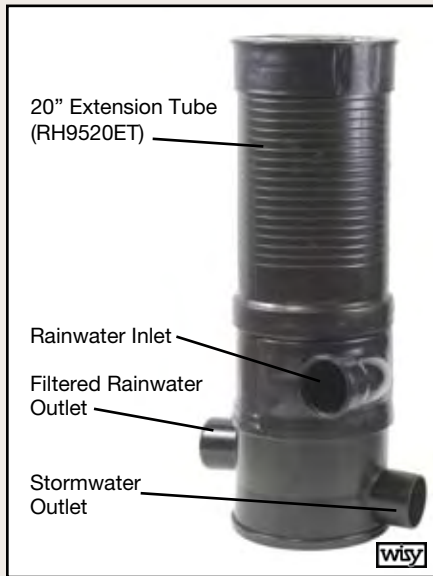

Figure Number: RH9518-04 – 4" Sewer and Drain Outlet

FUNCTION: The vortex rainwater fine filter is typically installed in the underground piping system to remove debris from the storm water system and divert 90% of clean rainwater to an underground storage tank. (An above grade application is possible). The filter operates as a first flush device. The filter assembly consists of a 12 inch stainless steel lift handle, removable stainless steel 280 micron fine mesh filter and polypropylene filter housing, upper ring, and housing lid. The mesh filter should be cleaned at least twice a year. The housing lid carries loads up to 30 tons (DIN 1072/SLW30).

Regularly Furnished:

Polypropylene Filter Housing, Upper Ring, and Housing Lid (RH9518-04)
 280 micron Stainless Steel Fine Mesh Filter (RH9518F)
 12" (305) Stainless Steel Lift Handle (RH9520LH12)

Accessories:

- Blind Insert (RH9518BI)
Used in place of the mesh filter to divert flow directly to the storm water system. Stainless Steel.
- 20" (510) Extension Tube (RH9520ET)
This Polypropylene tube is used for inspection and as an access opening to the ground level. It is fitted with a collar to accept the lid. It is easily cut to length using the molded-in parallel lines. Up to three extension tubes can be combined.
- Stainless Steel Wall Bracket (RH9520WB)
For securing the filter unit to a wall in above grade applications.

How the Vortex Rainwater Filter Works

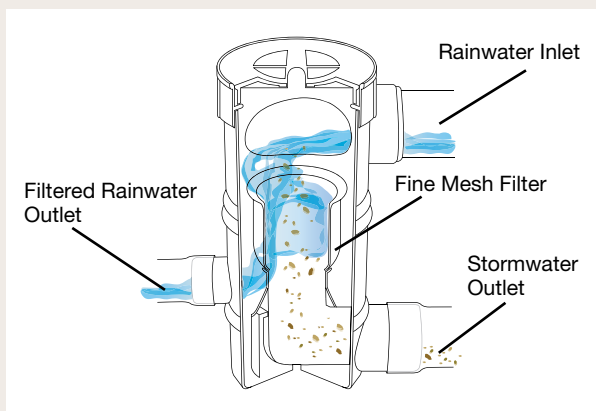

Options:

- 25" (635) Stainless Steel Lift Handle (RH9520LH25)
To remove mesh filter for cleaning.
- 39" (990) Stainless Steel Lift Handle (RH9520LH39)
To remove mesh filter for cleaning.

Product Catalog

RH9520-06, 6" Outlet - Vortex Rainwater Fine Filter for Above or Below Grade Applications for Roof Area Up to 5,500 Square Feet

Used in installations where multiple downspouts are connected together to a single pipe into the vortex filter. The vortex rainwater filter can filter up to a 5,500 square foot roof area for site irrigation, toilet and urinal flushing, janitorial use, laundries, fire protection, evaporative cooling tower make-up, process water, or other non-potable uses.

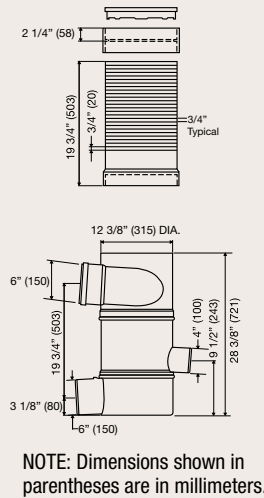

Figure Number: RH9520-06 – 6" Sewer and Drain Outlet

FUNCTION: The vortex rainwater fine filter is typically installed in the underground piping system to remove debris from the storm water system and divert 90% of clean rainwater to an underground storage tank. (An above grade application is possible). The filter operates as a first flush device. The filter assembly consists of a 12 inch stainless steel lift handle, removable stainless steel 280 micron fine mesh filter and polypropylene filter housing, upper ring, and housing lid. The mesh filter should be cleaned at least twice a year. The housing lid carries loads up to 30 tons (DIN 1072/SLW30).

Regularly Furnished:

- Polypropylene Filter Housing, Upper Ring, and Housing Lid (RH9520-06)
- 280 micron Stainless Steel Fine Mesh Filter (RH9520F)
- 12" (305) Stainless Steel Lift Handle (RH9520LH12)

Accessories:

- Blind Insert (RH9520BI)
Used in place of the mesh filter to divert flow directly to the storm water system. Stainless Steel.
- 20" Extension Tube (RH9520ET)
This polypropylene tube is used for inspection and as an access opening to the ground level. It is fitted with a collar to accept the lid. Is easily cut to length due to molded-in parallel lines. Up the three extension tubes can be combined together.
- Stainless Steel Wall Bracket (RH9520WB)
For securing the filter unit to a wall in above ground applications.

How the Vortex Rainwater Filter Works

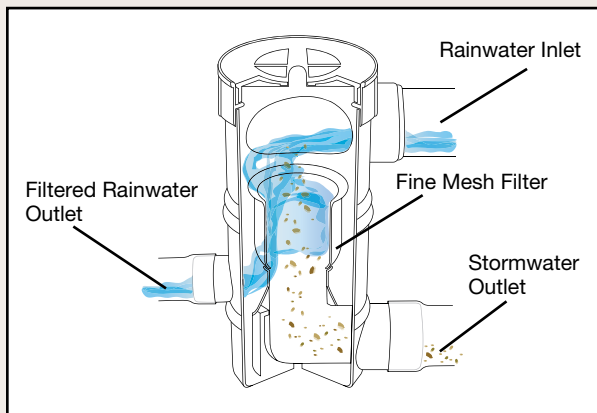

Options:

- 25 inch Stainless Steel Lift Handle (RH9520LH25)
To remove mesh filter for cleaning.
- 39 inch Stainless Steel Lift Handle (RH9520LH39)
To remove mesh filter for cleaning.

RH9521-12, 12" Outlet - Vortex Rainwater Fine Filter for Above or Below Grade Application for Roof Area up to 32,000 Square Feet

Used in installations where multiple downspouts are connected together to a single pipe into the vortex filter. The vortex rainwater filter can filter up to a 32,000 square foot roof area for site irrigation, toilet and urinal flushing, janitorial use, laundries, fire protection, evaporative cooling tower make-up, process water or other non-potable uses.

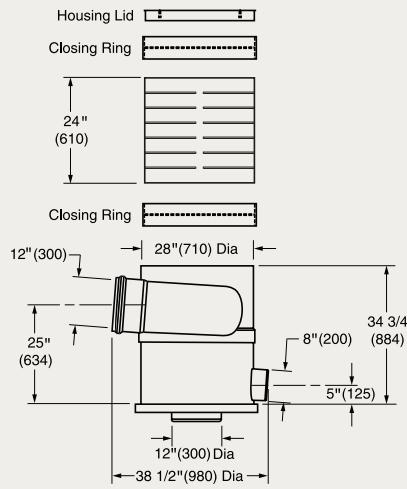

Figure Number: RH9521-12 – 12" Sewer and Drain Outlet, Steel Lid Carries Traffic Loads Up to 12 Tons (DIN 1072/SLW12)
Figure Number: RH9521-12XH – 12" Sewer and Drain Outlet, Steel Lid Carries Traffic Loads Up to 60 Tons (DIN 1072/SLW60)
Figure Number: RH9521-12AC – 12" Sewer and Drain Outlet, Aluminum Lid for Light Traffic Areas (DIN 1989/SLW3)

FUNCTION: The vortex rainwater fine filter is installed in the underground piping system to remove debris to the storm water system and divert 90% of clean rainwater to an underground storage tank. (An above grade application is possible). The filter operates as a first flush device. The filter assembly consists of a 20 inch stainless steel lift handle, removable stainless steel 380 micron fine mesh filter, steel housing lid and baseplate, and polypropylene filter housing with closing ring. The mesh filter should be cleaned at least twice a year. The housing lid (as specified) carries loads up to 60 tons (DIN 1072/SLW60).

Regularly Furnished:

- Polypropylene Filter Housing, Closing Ring, Baseplate, and Housing Lid (RH9521-12)
- 380 micron Stainless Steel Fine Mesh Filter (RH9521F)
- 20 inch Stainless Steel Lift Handle (RH9521LH20)
- Closing Ring and Safety Kit (RH9521SK)
- To connect cover and prevent falling into filter housing.
- 28" Sq. 11 Ga. Stainless Steel Support Baseplate

Accessories:

- 20 inch Stainless Steel Extension Handle (RH9521EX20)
- 36 inch Stainless Steel Extension Handle (RH9521EX36)
- To extend the lift handle for removal of the mesh filter for cleaning.
- Extension Tube (RH9521EXT) Available in 2 ft. increments.
- 24" Extension Assembly (RH9521ET)
- 48" Extension Assembly (RH9521ET-48)

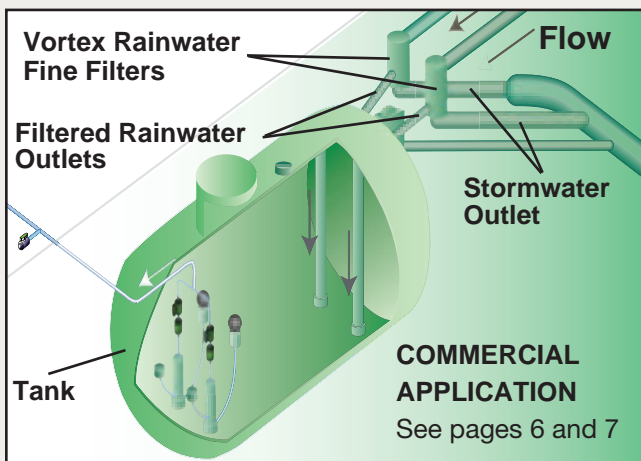

Safety Kit Plate
(RH9521SK)

STORAGE TANKS AND COMPONENTS

Storage tanks for the harvested rainwater make stored rainwater available when needed. Storage tanks reduce stormwater runoff into local waterways, save money by reducing dependence on municipal water sources, and make water available in times of drought. Depending on the space available these tanks can be constructed above grade, partly underground, or below grade. The polyethylene tanks are the most common for smaller systems. Fiberglass and steel tanks are commonly used for larger systems. To prevent agitation of sediment, to transport rainwater for reuse, and to maintain rainwater levels within a storage tank, pumps, filters, and/or overflow devices may be needed. Storage tanks can be connected in a series for increased storage needs.

RAINWATER HARVESTING STORAGE TANK PROVIDERS

Contact your local Jay R. Smith Mfg. Co. Representative for assistance with tanks and to find a local provider.

STORAGE TANK COMPONENTS

Smoothing Inlet

The Smoothing Inlet is used to prevent the agitation of sediment at the rainwater inlet into the storage tank or cistern. It also helps aerate the water as the rainwater enters the tank.



FUNCTION: An all stainless steel device that fits on a 4" or 8" inlet pipe.

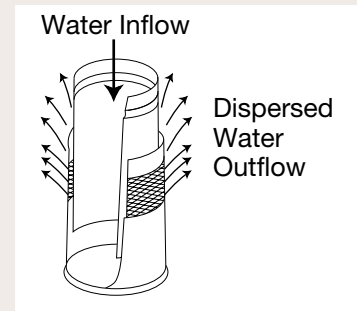
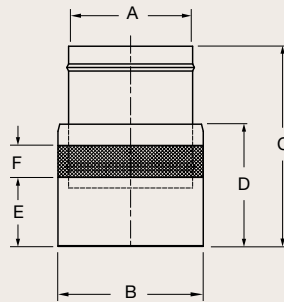

Figure Number: RH9530SI-04
Figure Number: RH9530SI-08

SMOOTHING INLET	A	B	C	D	E	F
RH9530SI-04	4" (100)	5 1/8" (130)	7 1/16" (180)	4 1/4" (110)	2 3/8" (60)	1 1/8" (29)
RH9530SI-08	8" (200)	12" (305)	7 1/16" (180)	4 7/8" (124)	2 3/8" (60)	2 1/2" (64)

NOTE: Dimensions shown in parentheses are in millimeters.

Storage Tank Floating Filters and Hoses

The floating filter is used to extract and filter rainwater out of the storage tank or pond. The filter allows for the extraction of the highest quality water.



1-1/4" Coarse Filter



1-1/4" Fine Filter



2" Coarse Filter



2" Fine Filter

Figure Number: RH9532C –Floating Filter with Coarse Filter (1200 micron) Housing, 1-1/4" Connection & 7' of Suction Pump Hose*

Figure Number: RH9532F –Floating Filter with Fine Filter (300 micron) Housing, 1-1/4" Connection & 7' of Suction Pump Hose*

Figure Number: RH9532C-2 –Floating Filter with Coarse Filter (1200 micron) Housing, 2" Connection & 7' of Suction Pump Hose*

Figure Number: RH9532F-2 –Floating Filter with Fine Filter (300 micron) Housing, 2" Connection & 7' of Suction Pump Hose*

FUNCTION: The filter housing and mesh fabric are made of stainless steel. The coarse filter with 1200 micron mesh and the fine filter with 300 micron mesh can be used with both submersible and suction pumps and come complete with 1-1/4" or 2" connection and hose. Floating ball is made of ecologically harmless polyethylene.

*For longer hose lengths, contact your local representative.

Rainwater Harvesting



FOUR STEPS TO A SUSTAINABLE RAINWATER HARVESTING SOLUTION FOR ROOF AREAS UP TO 5,500 SQUARE FEET

Drawing for illustration purposes only.

Illustrated is an example of how a rainwater harvesting system could be used in a residential application.

Harvested rainwater can be used for:

- Toilets
- Irrigation
- Laundries or
- Other non-potable uses.

Rainwater is collected on the catchment area; generally a roof top.



Vortex Rainwater Fine Filter for Above or Below Grade Applications

Figure Number: RH9520-06

- 1 At the point of discharge, the high capacity vortex rainwater filter removes large and fine debris and oxygenates the water.



Smoothing Inlet
Fig. #RH9530SI

NOTE: During low rainfall events, an alternative make-up water source such as the city or county water system is required to supply the home's water needs. The appropriate backflow preventer assemblies, per the local jurisdiction, are required for this application.

- 2 From the filter, the collected water enters the storage tank or cistern through the smoothing inlet which prevents agitation of sediment and evenly distributes the oxygenated water.



Float Switch
Fig. #RH9542FSO – Dry Run Protection, Normally Open (N/O)

Pump



Storage Tank Floating Filter and Hose

Fig. #RH9532C

- 3 The floating filter and pump extracts the harvested rainwater from the cleanest part of the tank, just below the water surface for use in the house.



Figure Number: RH9530DOK – Multi-functional Overflow Device

- 4 The overflow/backwater device in the tank is designed to skim floating particles from the surface of the water when the storage unit overflows.

Overflow from a rainwater system can be used for groundwater recharge, reducing stormwater runoff.

Tank

Water quality in the tank is maintained by removing the organic matter and by the action of incoming water which introduces oxygen. Water that is kept aerobic in this way does not become malodorous even when stored for long periods.

Components of Rainwater Harvesting System Packages:

	Package 1	Package 2	Package 3	Package 4	Package 5	Package 6	Package 7
Garden Pump	•						
Suction Pump		•	•	•	•	•	•
In-line Filter Collector	•		•				
Standpipe Filter Collector		•					
Vortex Rainwater Fine Filter				•	•	•	
Vortex Rainwater Fine Filter with Extension							•
Wall Bracket	•	•	•	•	•	*	
Downspout Converter Kit	•	•	•				
1" Flexible Hose	•	•	•				
Floating Filter and Hose		•	•	•	•	•	•
Smoothing Inlet				•	•	•	•
Multi-functional Overflow Kit							•
Float Switch		*	*	*	•	•	•
Level Indicator				•	•	•	
Purification Kit				*	*	*	*

* Denotes optional components

Selecting a Rainwater Harvesting Package by Roof Area:

Roof Area in Square Feet			
1,600	2,000	2,200	5,500

Packages (*Add additional packages for increased roof area).

Package 1, RH9500-01 - In-line Above Grade Garden Package	1 ea.			
Package 2, RH9500-02 - Standpipe Below Grade Package	1 ea.	1 ea.		
Package 3, RH9500-03 - In-line Above Grade Package	1 ea.			
Package 4, RH9500-04 - Above Grade Package				1 ea.
Package 5, RH9500-05 - Above Grade Package, Potable				1 ea.
Package 6, RH9500-06 - Above Grade Package			1 ea.	
Package 7, RH9500-07 - Below Grade Package, Potable				1 ea.

So How Do I Calculate How Much Rainwater Can Be Harvested?

Average Rainfall per Month x Roof Area (sq. ft.) x .62 (Roof-Type Coefficient) x The Filter Collection Efficiency of .90 = Gallons per Month

Did you know: One inch of rain on a 1,000 square-foot roof yields approximately 623 gallons of water.

U.S. Department of Housing and Urban Development





PACKAGE 1: RH9500-01

In-line Above Grade Garden Rainwater Harvesting Package for Roof Area Up to 1,600 Sq. Ft. at a Single Downspout

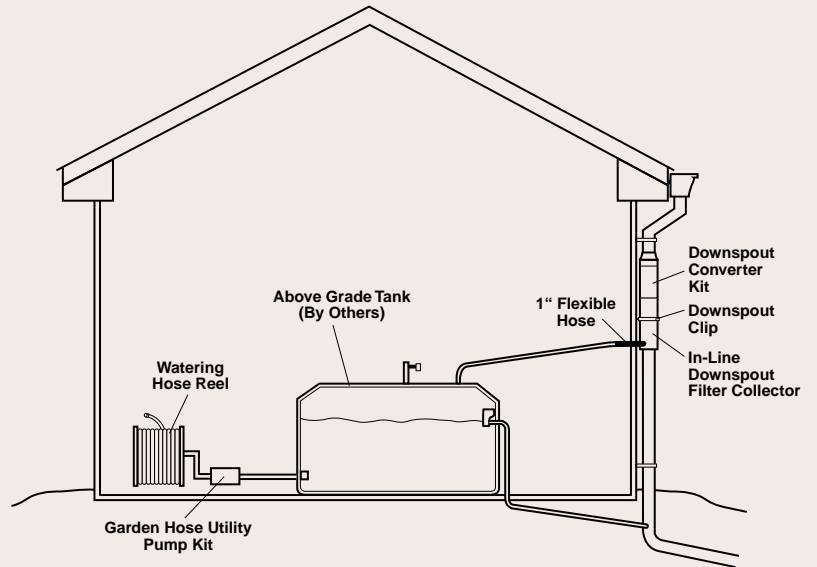

Drawing for illustration purposes only.

Order Figure Number: RH9500-01

FUNCTION: Single downspout rainwater system with rainwater downspout filter collector and pump. The package works on roof areas up to 1,600 square feet to collect rainwater for landscaping, lawn irrigation, car washing, or other non-potable uses.

Regularly Furnished: Downspout filter collector (Fig. # RH9510-04), and downspout clip (Fig #RH9510SC); 1" flexible hose (Fig. # RH9510TH) with 2" connection to connect filter to storage tank; downspout converter kit to connect downspout to filter (specify size); and garden hose utility pump kit (Fig. # RH9540GP).

Specify Downspout Converter Kit:
2" x 3" Kit – **Figure Number:** RH9510DK3
3" x 4" Kit – **Figure Number:** RH9510DK4

For roof area above 1,600 square feet see "Selecting a Rainwater Harvesting Package by Roof Area" on page 16.

Rainwater Harvesting Storage Tank Providers, Page 14.
See product catalog page 9 for component descriptions.

Product Selection

PACKAGE 2: RH9500-02

Standpipe Below Grade Rainwater Harvesting Package for Roof Area Up to 2,000 Sq. Ft. at a Single Downspout

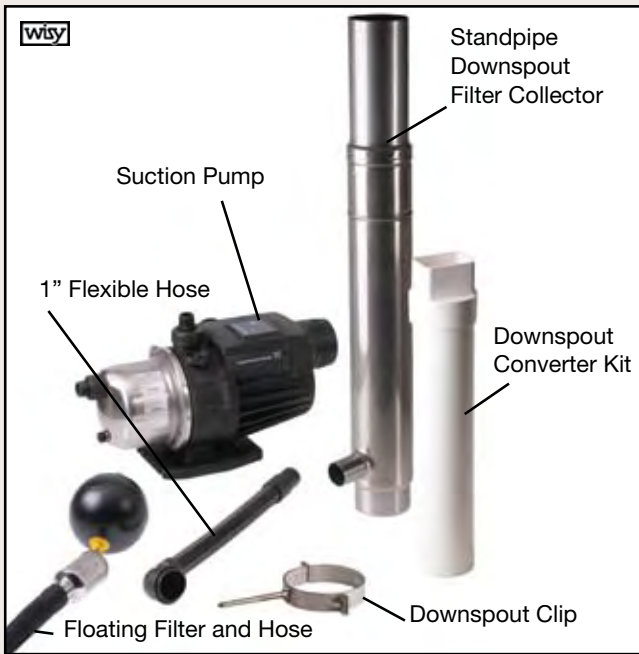

Order Figure Number: RH9500-02

FUNCTION: Single downspout rainwater system with rainwater standpipe filter collector, storage tank floating filter, and pump. The standpipe package works on roof areas up to 2,000 square feet to collect rainwater for landscaping, lawn irrigation, car washing, or other non-potable uses.

Specify Suction/Booster Pump Voltage:

115 Volts – **Figure Number:** RH9540-1BP115
 220 Volts – **Figure Number:** RH9540-1BP220

Specify Course or Fine Floating Filter:

Floating Filter with Coarse Filter Housing – **Figure Number:** RH9532C
 Floating Filter with Fine Filter Housing – **Figure Number:** RH9532F

Optional Component:

Float Switch for Dry Run Protection – **Figure Number:** RH9542FSO

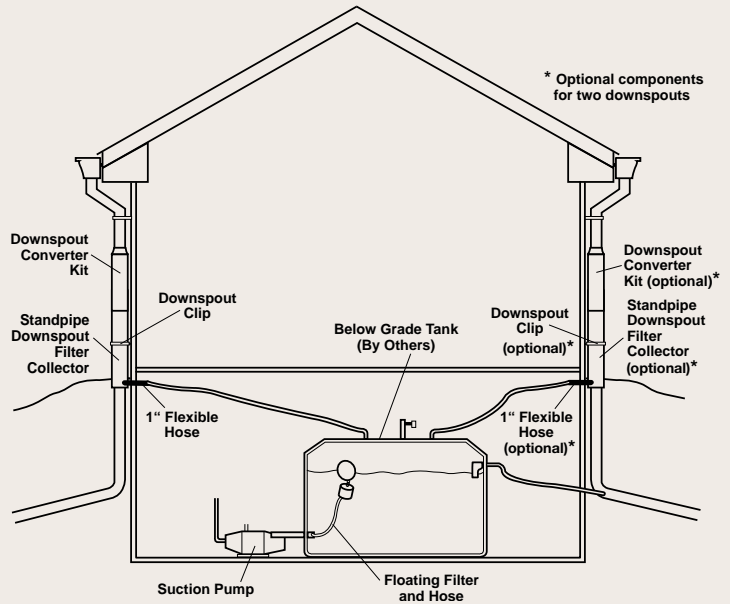

Drawing for illustration purposes only.
 (Shown with two packages)

Regularly Furnished: Downspout filter collector (Fig. # RH9511-04) and downspout clip (Fig. #RH9510SC); 1" flexible hose (Fig. # RH9510TH) with 2" connection to connect filter to storage tank; downspout converter kit to connect downspout to filter (specify size); floating filter (specify coarse or fine filter); and pump (specify voltage).

Specify Downspout Converter Kit:

2" x 3" Kit – **Figure Number:** RH9510DK3
 3" x 4" Kit – **Figure Number:** RH9510DK4

Rainwater Harvesting Storage Tank Providers, Page 14.

See product catalog pages 10, 14 and 25 for component descriptions.

For roof area above 2,000 square feet see "Selecting a Rainwater Harvesting Package by Roof Area" on page 16.

PACKAGE 3: RH9500-03

In-Line Above Grade Rainwater Harvesting Package for Roof Area Up to 1,600 Sq. Ft. at a Single Downspout



Order Figure Number: RH9500-03

FUNCTION: Single downspout rainwater system with rainwater downspout filter collector, storage tank floating filter, and pump. The package works on roof areas up to 1,600 square feet to collect rainwater for landscaping, lawn irrigation, car washing, or other non-potable uses.

Specify Downspout Converter Kit:

2" x 3" Kit – **Figure Number:** RH9510DK3

3" x 4" Kit – **Figure Number:** RH9510DK4

Specify Suction/Booster Pump Voltage:

115 Volts – **Figure Number:** RH9540-1BP115

220 Volts – **Figure Number:** RH9540-1BP220

Specify Course or Fine Floating Filter:

Floating Filter with Coarse Filter Housing – **Figure Number:** RH9532C

Floating Filter with Fine Filter Housing – **Figure Number:** RH9532F

Optional Component:

Float Switch for Dry Run Protection – **Figure Number:** RH9542F50

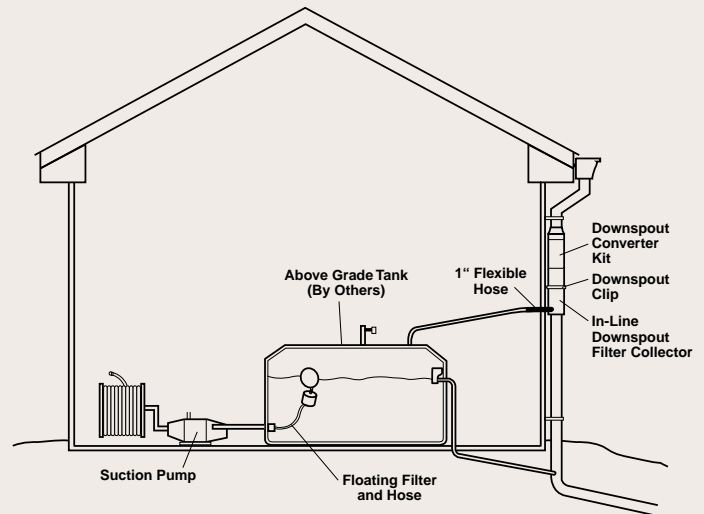

Drawing for illustration purposes only.

Regularly Furnished: Downspout filter collector (Fig. # RH9510-04) and downspout clip (Fig. #RH9510SC); 1" flexible hose (Fig. # RH9510TH) with 2" connection to connect filter to storage tank; downspout converter kit to connect downspout to filter (specify size); floating filter (specify coarse or fine filter); and pump (specify voltage).

Rainwater Harvesting Storage Tank Providers, Page 14.

For roof area above 1,600 square feet see "Selecting a Rainwater Harvesting Package by Roof Area" on page 16.

See product catalog pages 9, 14 and 25 for component descriptions.

PACKAGE 4: RH9500-04

Above Grade Rainwater Harvesting Package for Roof Area Up to 5,500 Sq. Ft.

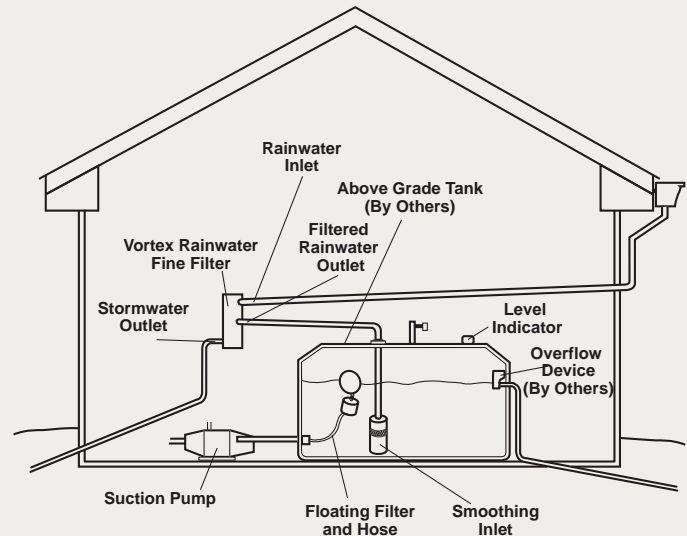
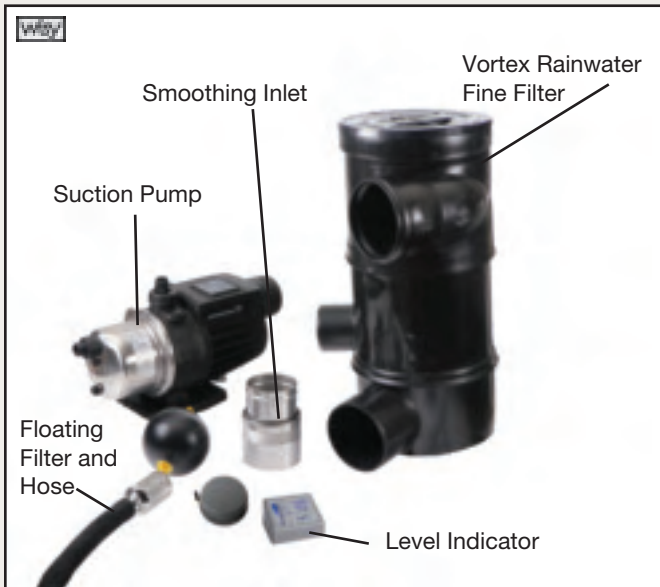

Drawing for illustration purposes only.

Order Figure Number: RH9500-04

FUNCTION: Rainwater system with vortex rainwater fine filter, storage tank floating filter, smoothing inlet, level indicator and pump. The package works on roof areas up to 5,500 square feet to collect rainwater for site irrigation, toilet and urinal flushing, janitorial use, fire protection, evaporative cooling tower make-up, process water, or other non-potable uses.

Regularly Furnished: Vortex rainwater fine filter (Fig. # RH9520-06) with wall bracket (Fig. # RH9520WB); floating filter (specify coarse or fine filter); smoothing inlet (Fig. # RH9530SI-04); storage tank level indicator (Fig. # RH9530LI); and pump (specify voltage).

Specify Suction/Booster Pump Voltage:

115 Volts – **Figure Number:** RH9540-1BP115

220 Volts – **Figure Number:** RH9540-1BP220

Specify Course or Fine Floating Filter:

Floating Filter with Coarse Filter Housing – **Figure Number:** RH9532C

Floating Filter with Fine Filter Housing – **Figure Number:** RH9532F

Optional Components:

Float Switch for Dry Run Protection – **Figure Number:** RH9542FSO

Purification Kit - **Figure Number:** RH9550PK*

* To purchase, the Purification Kit must be approved by a licensed plumbing engineer.

Rainwater Harvesting Storage Tank Providers, Page 14.

NOTE: For roof area above 5,500 square feet see “Selecting a Rainwater Harvesting Package by Roof Area” on page 16.

See product catalog pages 12, 14 and 24-25 for component descriptions.

PACKAGE 5: RH9500-05
Above Grade Rainwater Harvesting Package with Optional Purification Kit
for Roof Area Up to 5,500 Sq. Ft.

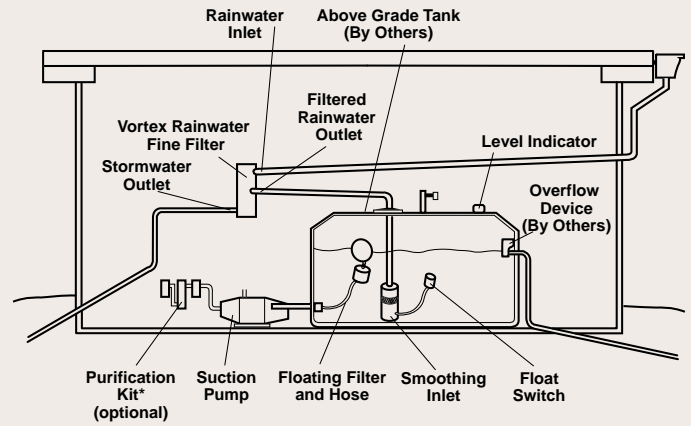
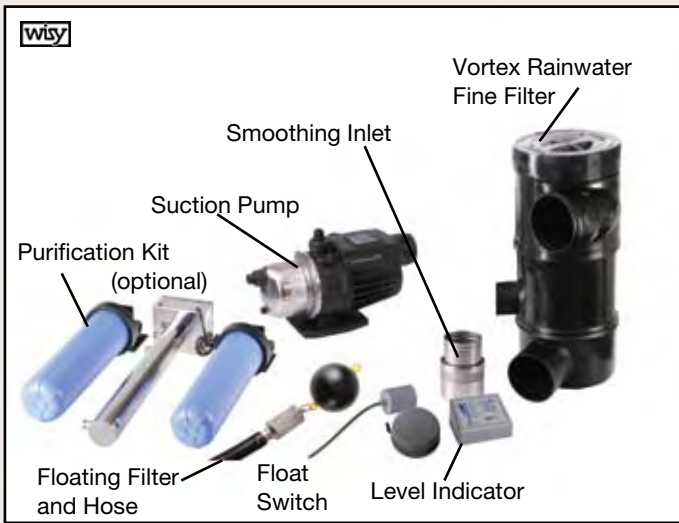

Drawing for illustration purposes only.

Order Figure Number: RH9500-05

FUNCTION: Rainwater system with vortex rainwater fine filter, storage tank floating filter, smoothing inlet, float switch, level indicator, purification kit* (optional) and pump. The package works on roof areas up to 5,500 square feet to collect rainwater for site irrigation, toilet and urinal flushing, janitorial use, fire protection, evaporative cooling tower make-up, process water, showers, washing machines, dishwashers, and other potable or non-potable uses.

Regularly Furnished: Vortex rainwater fine filter (Fig. #RH9520-06) with wall bracket (Fig. #RH9520WB); floating filter (specify coarse or fine filter); smoothing inlet (Fig. # RH9530SI-04); storage tank level indicator (Fig. # RH9530LI); float switch for dry run protection (Fig. #RH9542FSO); and pump (specify voltage).

Optional Component:

Purification Kit – Figure Number: RH9550PK*, complete with 20” filter housing (2), string wound 1 micron sediment filter, carbon filter for odor and taste, mounting brackets (2), filter wrenches (2), and 15 gpm ultraviolet light.

* To purchase, the Purification Kit must be approved by a licensed plumbing engineer.

Specify Suction/Booster Pump Voltage:

115 Volts – **Figure Number:** RH9540-1BP115

220 Volts – **Figure Number:** RH9540-1BP220

Specify Course or Fine Floating Filter:

Floating Filter with Coarse Filter Housing – **Figure Number:** RH9532C

Floating Filter with Fine Filter Housing – **Figure Number:** RH9532F

Rainwater Harvesting Storage Tank Providers, Page 14.

NOTE: For roof area above 5,500 square feet see “Selecting a Rainwater Harvesting Package by Roof Area” on page 16.

See product catalog pages 12, 14 and 24-25 for component descriptions.

Product Selection

PACKAGE 6: RH9500-06

Above Grade Rainwater Harvesting Package for Roof Area Up to 2,200 Sq. Ft.

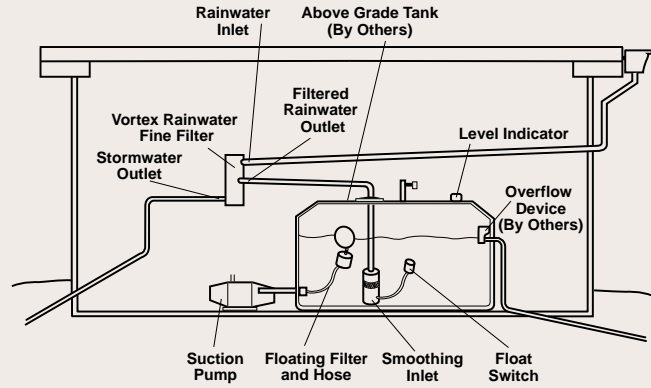

Drawing for illustration purposes only.

Order Figure Number: RH9500-06

FUNCTION: Rainwater system with vortex rainwater fine filter, storage tank floating filter, smoothing inlet, level indicator, float switch, and pump. The package works on roof areas up to 2,200 square feet to collect rainwater for site irrigation, toilet and urinal flushing, janitorial use, fire protection, evaporative cooling tower make-up, process water, or other non-potable uses.

Regularly Furnished: Vortex rainwater fine filter (Fig. # RH9518-04) ; floating filter with filter housing, (specify coarse or fine filter); smoothing inlet (Fig. # RH9530SI-04); storage tank level indicator (Fig. # RH9530LI); float switch for dry run protection (Fig. # RH9542FSO); and pump (specify voltage).

Specify Suction/Booster Pump Voltage:

115 Volts – **Figure Number:** RH9540-1BP115

220 Volts – **Figure Number:** RH9540-1BP220

Specify Course or Fine Floating Filter:

Floating Filter with Coarse Filter Housing – **Figure Number:** RH9532C

Floating Filter with Fine Filter Housing – **Figure Number:** RH9532F

Optional Components:

Purification Kit - **Figure Number:** RH9550PK*

* To purchase, the Purification Kit must be approved by a licensed plumbing engineer.

Stainless Steel Wall Bracket - **Figure Number:** RH9520WB

Rainwater Harvesting Storage Tank Providers, Page 14.

NOTE: For roof area above 5,500 square feet see “Selecting a Rainwater Harvesting Package by Roof Area” on page 16.

See product catalog pages 12, 14 and 24-25 for component descriptions.

PACKAGE 7: RH9500-07

Below Grade Rainwater Harvesting Package with Optional Purification Kit for Roof Area Up to 5,500 Sq. Ft.

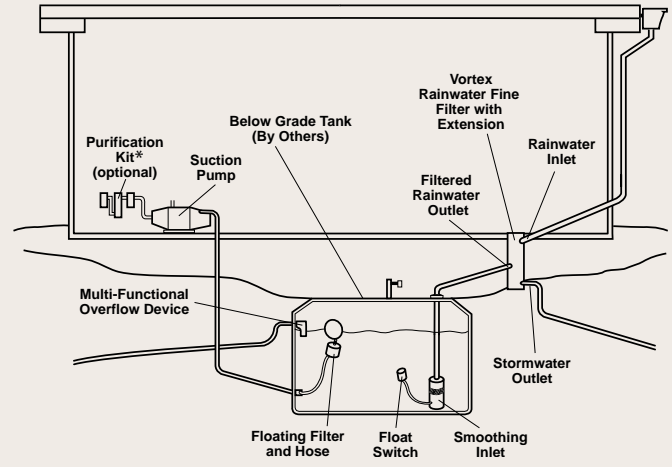

Drawing for illustration purposes only.

Order Figure Number: RH9500-07

FUNCTION: Rainwater system with vortex rainwater fine filter, storage tank floating filter, smoothing inlet, multi-functional overflow device, float switch, purification kit (optional) and pump. The package works on roof areas up to 5,500 square feet to collect rainwater for site irrigation, toilet and urinal flushing, janitorial use, fire protection, evaporative cooling tower make-up, process water, showers, washing machines, dishwashers, and other potable or non-potable uses.

Regularly Furnished: Vortex rainwater fine filter with extension (Fig. # RH9520-06 and RH9520ET); floating filter (specify coarse or fine filter); smoothing inlet (Fig. # RH9530SI-04); multi-functional overflow device (Fig. # RH9530DOK); float switch for dry run protection (Fig. # RH9542FSO); and pump (specify voltage).

Optional Component:

Purification Kit – Figure Number: RH9550PK*, complete with 20” filter housing (2), string wound 1 micron sediment filter, carbon filter for odor and taste, mounting brackets (2), filter wrenches (2), and 15 g.p.m. ultraviolet light.

* To purchase, the Purification Kit must be approved by a licensed plumbing engineer.

Specify Suction/Booster Pump Voltage:

115 Volts – **Figure Number:** RH9540-1BP115

220 Volts – **Figure Number:** RH9540-1BP220

Specify Course or Fine Floating Filter:

Floating Filter with Coarse Filter Housing – **Figure Number:** RH9532C

Floating Filter with Fine Filter Housing – **Figure Number:** RH9532F

Rainwater Harvesting Storage Tank Providers, Page 14.

NOTE: For roof area above 5,500 square feet see “Selecting a Rainwater Harvesting Package by Roof Area” on page 16.

See product catalog pages 12, 14 and 24-25 for component descriptions.

RAINWATER HARVESTING PACKAGE COMPONENTS

Storage Tank Overflow Device

The overflow device is connected to the overflow pipe within the storage container. The device can prevent the entry of drain odors from the storm drain into the storage container, provides backflow protection, and removes surface debris through a skimming effect.

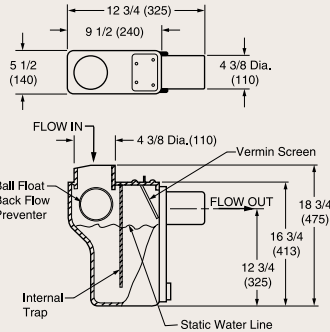

Figure Number: RH9530DOK – Multi-functional Overflow Device

FUNCTION: The Multi-functional overflow device is made of impact-resistant ABS plastic that eliminates drain odors in the storage tank, provides vermin and backflow protection, and skims surface debris. Comes with support strut, clamp, and fits 4 inch overflow piping.

Sensor Type Storage Tank Level Indicator

Sensor level indicator shows the water level in the storage container or cistern using a wireless device. This device transmits an ultrasonic sound wave that echoes back from the fluid surface. That echo is converted to a depth and displayed on the indoor bench unit indicating the depth of the water in the storage tank.



Figure Number: RH9530LI

FUNCTION: Wireless sensor that gives remote tank level readings. Sensor has an operating range of up to 1,640 feet. The maximum detection range is 13 feet. Sensor and bench unit operate on four “AA” batteries.

Purification Kit (Optional Component for Packages 4, 5, 6 and 7)

Designed to treat rainwater for potable uses. To purchase, the Purification Kit must be approved by a licensed plumbing engineer.



FUNCTION: Treats rainwater for potable uses. Kit includes 20” filter housing (2), 1 string wound micron sediment filter, carbon filter for odor and taste, mounting brackets (2), filter wrench (2), and 15 g.p.m. ultraviolet light.

Figure Number: RH9550PK – Purification Kit

Suction/Booster Pump



1 Horsepower Suction/Booster Pump (Specify 115 or 220 volts, single phase) – **Figure Number:** RH9540-1BP, a complete unit includes a pump, motor, diaphragm tank, pressure and flow sensor, control and check valve for residential applications. The controller ensures that the pump starts automatically when water is consumed and stops automatically when the consumption ceases.

Operating specification for booster pump (RH9540-1BP):

System Pressure – Max. 110 psi (7.5 bar)
 Inlet Pressure – Max. 45 psi (3 bar)
 Suction Lift – Max. 26 ft. (8m)
 Liquid Temperature – 32°F to 95 °F
 Ambient Temperature – 32°F to 113 °F

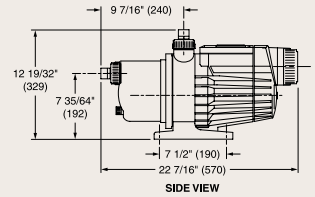

Pump Data and Weights

Pump Type	HP	Input Voltage	Inlet NPT	Discharge NPT	Max. Amps	Ship Weight
RH9540-1BP115	1	110 - 120	1"	1"	9.2	30 lbs.
RH9540-1BP220	1	220 - 240	1"	1"	4.5	30 lbs.

Specify Suction/Booster Pump Voltage:

115 Volts – **Figure Number:** RH9540-1BP115
 220 Volts – **Figure Number:** RH9540-1BP220

Float Switches



FUNCTION: The Normally Open Float Switch is necessary to provide dry run protection for the pump. If the water level in the tank reaches a minimum level, the Normally Open Float Switch closes to ensure the pump does not continue to pump and burn up. Once the tank fills to a level which allows the pump to activate, the switch opens and allows the pump to continue operation. The switch is normally attached to the inlet pipe or the cistern pump.

Figure Number: RH9542FSO – Dry Run Protection, Normally Open (N/O)



FUNCTION: The Normally Closed Float Switch is used to open and close a solenoid valve. In the event the level in the tank reaches a minimum level, the Normally Closed Float Switch opens the closed solenoid valve to allow back up water to supply the system. Once the tank reaches a predetermined level, the Normally Closed Float Switch closes the solenoid valve to allow the rainwater system to operate normally.

Figure Number: RH9542FSC – Back-up Water Feed, Normally Closed (N/C)

So How Do I Calculate How Much Rainwater Can Be Harvested?

Average Rainfall per Month x Roof Area (sq. ft.) x .62 (Roof-Type Coefficient) x The Filter Collection Efficiency of .90 = Gallons per Month



Did you know: Storage tanks act as quantity controls and can help reduce the cumulative effect of stormwater on downstream systems.

U.S. Department of Housing and Urban Development

LEED® / GREEN BUILDING DESIGN—A GREEN IDEA

The LEED® (Leadership in Energy and Environment Design) Green Building Rating System™ was devised as a voluntary, consensus-based national standard for developing high-performance, sustainable buildings. LEED was initially created by the U.S. Green Building Council (USGBC) to establish a common measurement to define “green building.” It has since grown into a program aimed at raising awareness of and promoting integrated “green” building projects.

How does a building become a “green” building? Through design and construction that concentrates on:

- Sustainable Sites
- Water Efficiency
- Energy and Atmosphere
- Materials and Resources
- Indoor Environmental Quality
- Innovation in Design
- Regional Priority

To become LEED certified, the building is rated by these six categories. Within each category, points are awarded based on the LEED Green Building Rating System™.

LEED awards points to building designs for a variety of energy-efficient and environmentally friendly features, from the installation of radiant heating to reduction of energy consumption, to grey water recycling, to the use of local building materials that require less energy to transport.

The green building movement is an essential part of the solution to the energy, resource, and climate issues our

country faces. In the United States, buildings annually account for 39% of the U.S. primary energy use; 70% of the U.S. resource consumption; consume 40% of raw materials globally; and use 12.2% of all potable water, or 15 trillion gallons per year.

LEED points are not given to individual products, but to an aggregate of the building system that saves water, energy, and contributes to a healthy indoor environment.

On average, a LEED certified building uses 30% less water than a conventional building, which translates to more than 1 million gallons of water saved per year. Reducing the amount of water that needs to be conveyed to and treated by municipal wastewater treatment facilities also reduces pumping and process energy required to these systems. LEED, through practices like rainwater harvesting, promotes on-site storage and use of rainwater to lower water consumption cost, and it reduces the impact on storm drainage and municipal treatment systems.

In general, Certified and Silver LEED projects tend to achieve the first irrigation and water use reduction point, using standard technologies at no additional cost. Gold and Platinum projects tend to achieve all 5 water points, typically at reasonable added cost, but there is a commitment to using new technologies, products and methods such as Rainwater Harvesting.

LEED and related logo is a trademark owned by the U.S. Green Building Council and is used by permission



For more information on our products or to contact your local Jay R. Smith Mfg. Co. representative, visit www.jrsmith.com.



Products featured in this catalog are promoted in cooperation with Rainwater Management Solutions (RMS) Salem, VA and WISY AG Haustechniksysteme, Filtertechnik.



This brochure was printed on recycled paper.



SMITH® **JAY R. SMITH MFG. CO.**
DIVISION OF SMITH INDUSTRIES, INC.
POST OFFICE BOX 3237
MONTGOMERY, ALABAMA 36109-0237 (USA)
TEL: 334-277-8520 FAX: 334-272-7396 www.jrsmith.com



Jay R. Smith Mfg. Co. Copyright © 2010 All Rights Reserved
SPM 2138 06/10